

Module 8: Memory Management

- Background
- Logical versus Physical Address Space
- Swapping
- Contiguous Allocation
- Paging
- Segmentation
- Segmentation with Paging

Background

- Program must be brought into memory and placed within a process for it to be executed.
- *Input queue* – collection of processes on the disk that are waiting to be brought into memory for execution.
- User programs go through several steps before being executed.

Binding of Instructions and Data to Memory

Address binding of instructions and data to memory addresses can happen at three different stages.

- **Compile time:** If memory location known a priori, *absolute* code can be generated; must recompile code if starting location changes.
- **Load time:** Must generate *relocatable* code if memory location is not known at compile time.
- **Execution time:** Binding delayed until run time if the process can be moved during its execution from one memory segment to another. Need hardware support for address maps (e.g., *base* and *limit* registers).

Dynamic Loading

- Routine is not loaded until it is called.
- Better memory-space utilization; unused routine is never loaded.
- Useful when large amounts of code are needed to handle infrequently occurring cases.
- No special support from the operating system is required; implemented through program design.

Dynamic Linking

- Linking postponed until execution time.
- Small piece of code, *stub*, used to locate the appropriate memory-resident library routine.
- Stub replaces itself with the address of the routine, and executes the routine.
- Operating system needed to check if routine is in processes' memory address.

Overlays

- Keep in memory only those instructions and data that are needed at any given time.
- Needed when process is larger than amount of memory allocated to it.
- Implemented by user, no special support needed from operating system; programming design of overlay structure is complex.

Logical vs. Physical Address Space

- The concept of a *logical address space* that is bound to a separate *physical address space* is central to proper memory management.
 - *Logical address* – generated by the CPU; also referred to as *virtual address*.
 - *Physical address* – address seen by the memory unit.
- Logical and physical addresses are the same in compile-time and load-time address-binding schemes; logical (virtual) and physical addresses differ in execution-time address-binding scheme.

Memory-Management Unit (MMU)

- Hardware device that maps virtual to physical address.
- In MMU scheme, the value in the relocation register is added to every address generated by a user process at the time it is sent to memory.
- The user program deals with *logical* addresses; it never sees the *real* physical addresses.

Swapping

- A process can be *swapped* temporarily out of memory to a *backing store*, and then brought back into memory for continued execution.
- Backing store – fast disk large enough to accommodate copies of all memory images for all users; must provide direct access to these memory images.
- *Roll out, roll in* – swapping variant used for priority-based scheduling algorithms; lower-priority process is swapped out so higher-priority process can be loaded and executed.
- Major part of swap time is transfer time; total transfer time is directly proportional to the *amount* of memory swapped.
- Modified versions of swapping are found on many systems, i.e., UNIX and Microsoft Windows.

Schematic View of Swapping

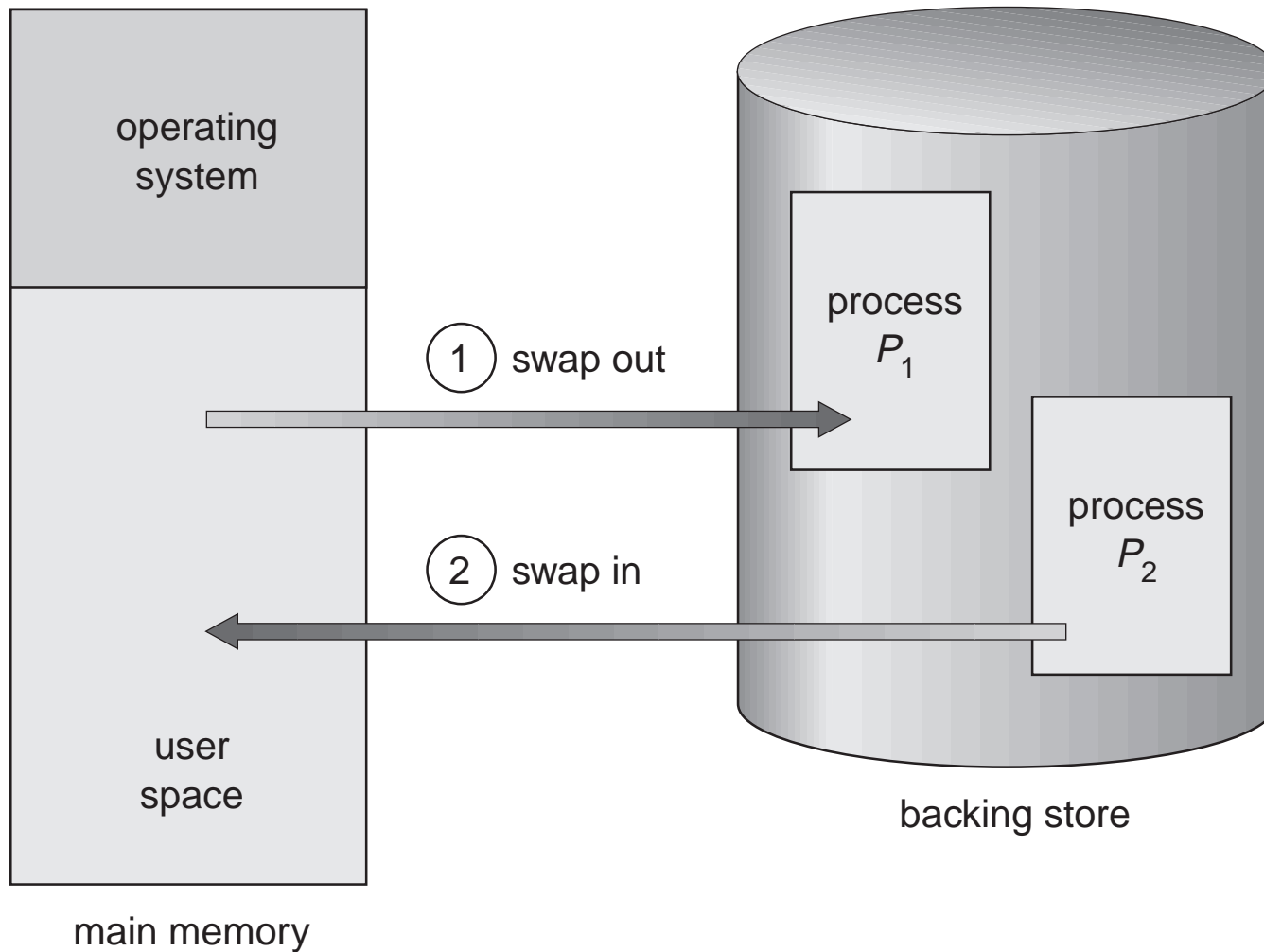

Contiguous Allocation

- Main memory usually into two partitions:
 - Resident operating system, usually held in low memory with interrupt vector.
 - User processes then held in high memory.
- Single-partition allocation
 - Relocation-register scheme used to protect user processes from each other, and from changing operating-system code and data.
 - Relocation register contains value of smallest physical address; limit register contains range of logical addresses – each logical address must be less than the limit register.

Contiguous Allocation (Cont.)

- Multiple-partition allocation
 - *Hole* – block of available memory; holes of various size are scattered throughout memory.
 - When a process arrives, it is allocated memory from a hole large enough to accommodate it.
 - Operating system maintains information about:
 - a) allocated partitions
 - b) free partitions (hole)

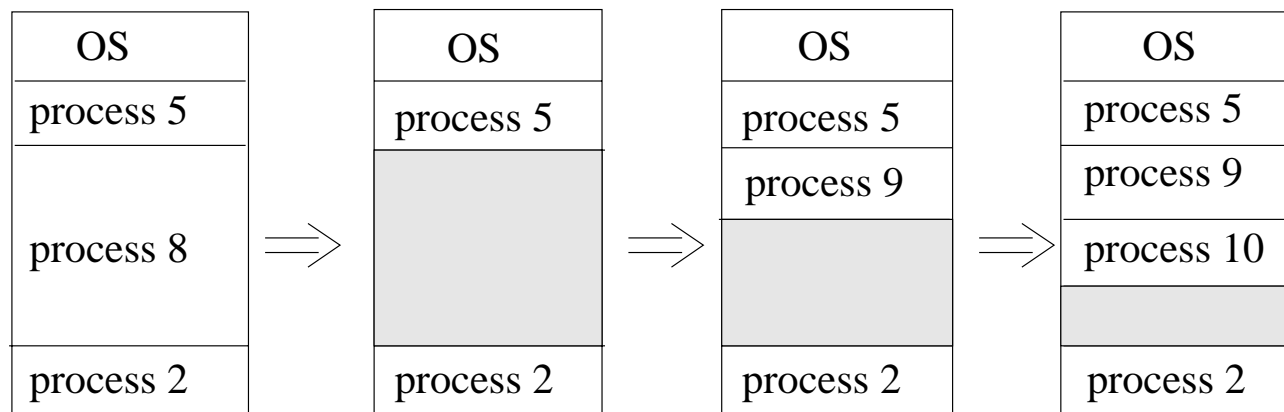

Dynamic Storage-Allocation Problem

How to satisfy a request of size n from a list of free holes.

- **First-fit:** Allocate the *first* hole that is big enough.
- **Best-fit:** Allocate the *smallest* hole that is big enough; must search entire list, unless ordered by size. Produces the smallest leftover hole.
- **Worst-fit:** Allocate the *largest* hole; must also search entire list. Produces the largest leftover hole.

First-fit and best-fit better than worst-fit in terms of speed and storage utilization.

Fragmentation

- External fragmentation – total memory space exists to satisfy a request, but it is not contiguous.
- Internal fragmentation – allocated memory may be slightly larger than requested memory; this size difference is memory internal to a partition, but not being used.
- Reduce external fragmentation by *compaction*.
 - Shuffle memory contents to place all free memory together in one large block.
 - Compaction is possible *only* if relocation is dynamic, and is done at execution time.
 - I/O problem
 - * Latch job in memory while it is involved in I/O.
 - * Do I/O only into OS buffers.

Paging

- Logical address space of a process can be noncontiguous; process is allocated physical memory wherever the latter is available.
- Divide physical memory into fixed-sized blocks called *frames* (size is power of 2, between 512 bytes and 8192 bytes).
- Divide logical memory into blocks of same size called *pages*.
- Keep track of all free frames.
- To run a program of size n pages, need to find n free frames and load program.
- Set up a page table to translate logical to physical addresses.
- Internal fragmentation.

Address Translation Scheme

- Address generated by CPU is divided into:
 - *Page number (p)* – used as an index into a *page table* which contains base address of each page in physical memory.
 - *Page offset (d)* – combined with base address to define the physical memory address that is sent to the memory unit.

Address Translation Architecture

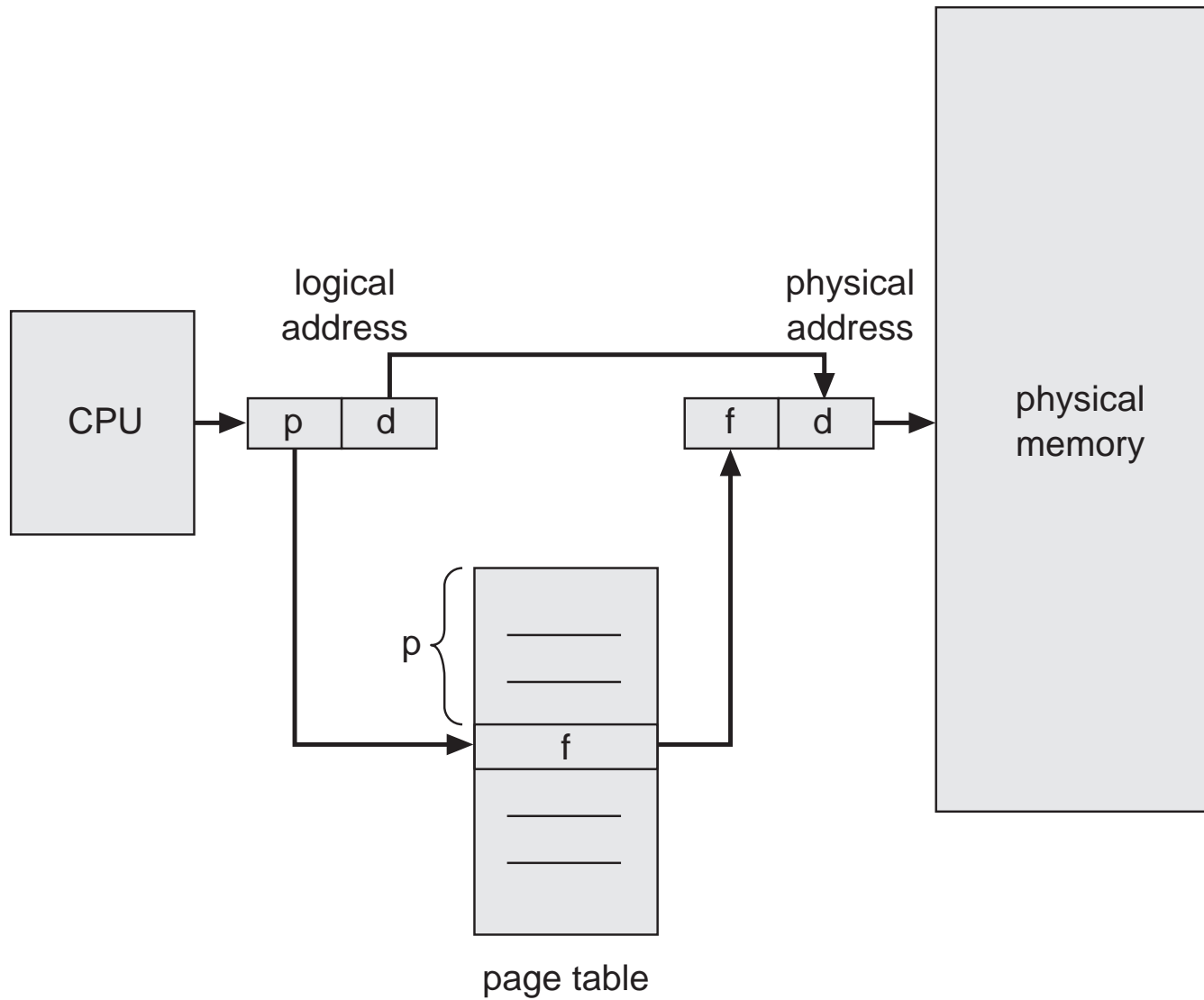

Paging Example

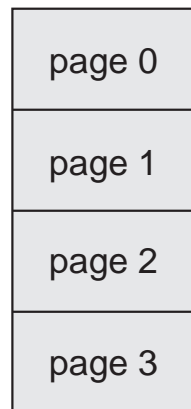

logical
memory

0	1
1	4
2	3
3	7

page table

frame
number

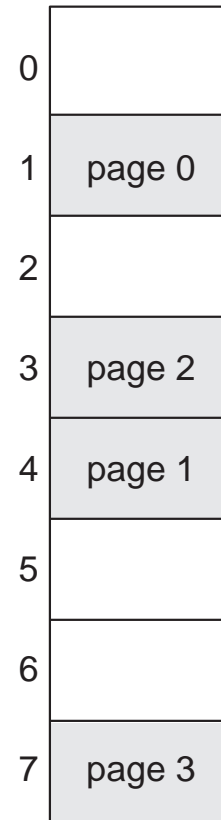

physical
memory

Implementation of Page Table

- Page table is kept in main memory.
- *Page-table base register (PTBR)* points to the page table.
- *Page-table length register (PTLR)* indicates size of the page table.
- In this scheme every data/instruction access requires two memory accesses. One for the page table and one for the data/instruction.
- The two memory access problem can be solved by the use of a special fast-lookup hardware cache called *associative registers* or *translation look-aside buffers (TLBs)*.

Associative Register

- Associative registers – parallel search

Page #	Frame #

Address translation (A' , A'')

- If A' is in associative register, get frame # out.
- Otherwise get frame # from page table in memory.

Effective Access Time

- Associative lookup = ϵ time unit
- Assume memory cycle time is 1 microsecond
- *Hit ratio* – percentage of times that a page number is found in the associative registers; ratio related to number of associative registers.
- Hit ratio = α
- Effective Access Time (EAT)

$$\begin{aligned} \text{EAT} &= (1 + \epsilon)\alpha + (2 + \epsilon)(1 - \alpha) \\ &= 2 + \epsilon - \alpha \end{aligned}$$

Memory Protection

- Memory protection implemented by associating protection bits with each frame.
- *Valid–invalid* bit attached to each entry in the page table:
 - “valid” indicates that the associated page is in the process’ logical address space, and is thus a legal page.
 - “invalid” indicates that the page is not in the process’ logical address space.

Two-Level Page-Table Scheme

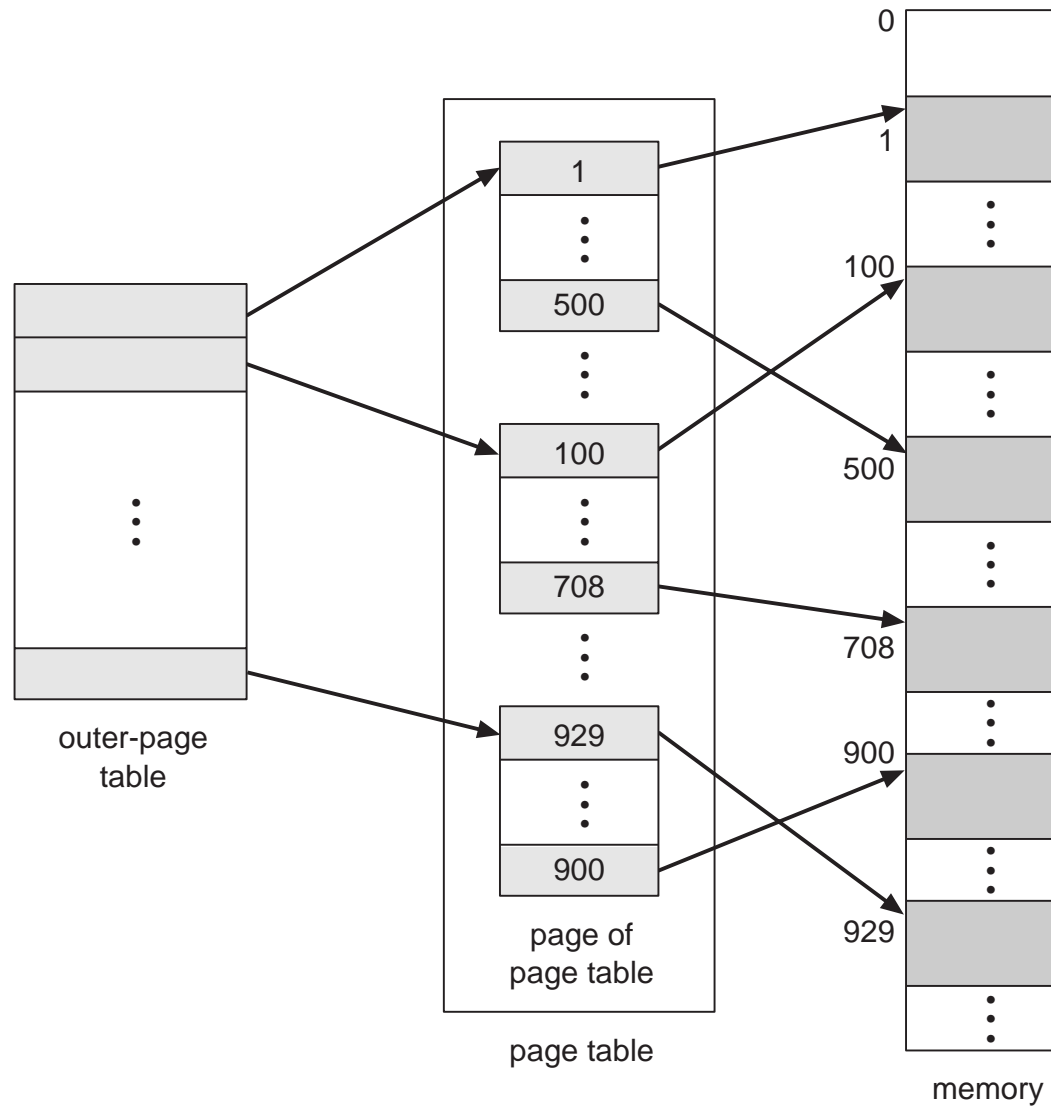

Two-Level Paging Example

- A logical address (on 32-bit machine with 4K page size) is divided into:
 - a page number consisting of 20 bits.
 - a page offset consisting of 12 bits.
- Since the page table is paged, the page number is further divided into:
 - a 10-bit page number.
 - a 10-bit page offset.
- Thus, a logical address is as follows:

page number		page offset
p_1	p_2	d
10	10	12

where p_1 is an index into the outer page table, and p_2 is the displacement within the page of the outer page table.

Address-Translation Scheme

- Address-translation scheme for a two-level 32-bit paging architecture

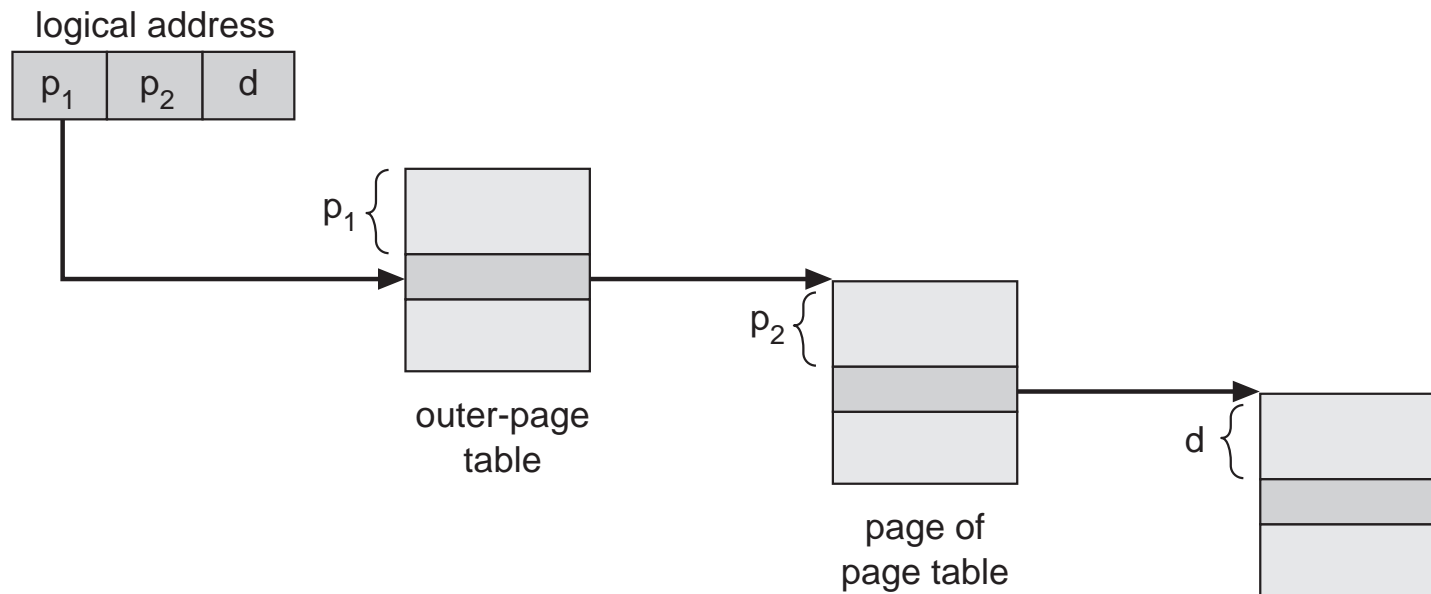

Multilevel Paging and Performance

- Since each level is stored as a separate table in memory, converting a logical address to a physical one may take four memory accesses.
- Even though time needed for one memory access is quintupled, caching permits performance to remain reasonable.
- Cache hit rate of 98 percent yields:

$$\begin{aligned}\text{effective access time} &= 0.98 \times 120 + 0.02 \times 520 \\ &= 128 \text{ nanoseconds.}\end{aligned}$$

which is only a 28 percent slowdown in memory access time.

Inverted Page Table

- One entry for each real page of memory.
- Entry consists of the virtual address of the page stored in that real memory location, with information about the process that owns that page.
- Decreases memory needed to store each page table, but increases time needed to search the table when a page reference occurs.
- Use hash table to limit the search to one — or at most a few — page-table entries.

Inverted Page Table Architecture

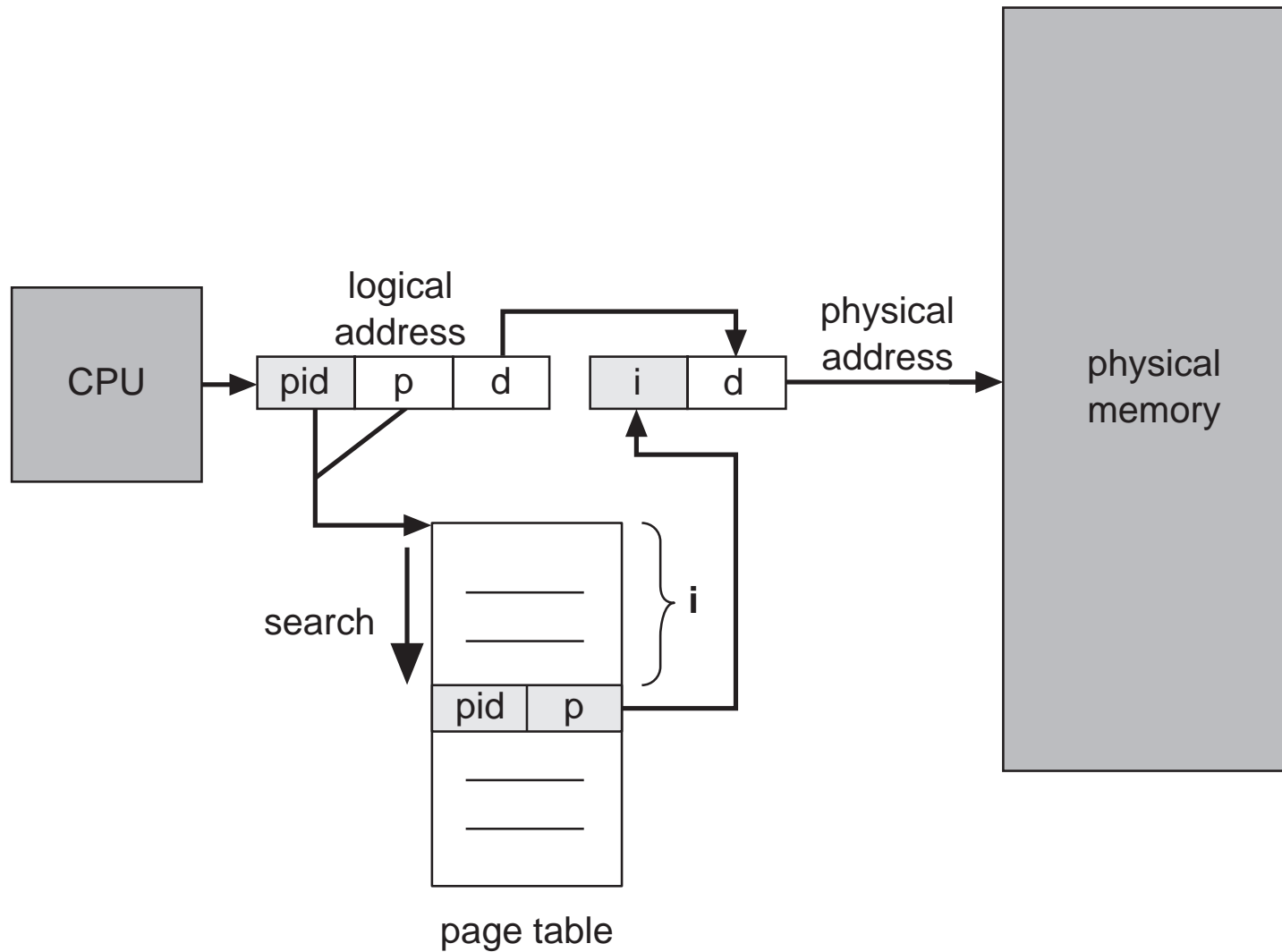

Shared Pages

- Shared code
 - One copy of read-only (reentrant) code shared among processes (i.e., text editors, compilers, window systems).
 - Shared code must appear in same location in the logical address space of all processes.
- Private code and data
 - Each process keeps a separate copy of the code and data
 - the pages for the private code and data can appear anywhere in the logical address space

Shared Pages Example

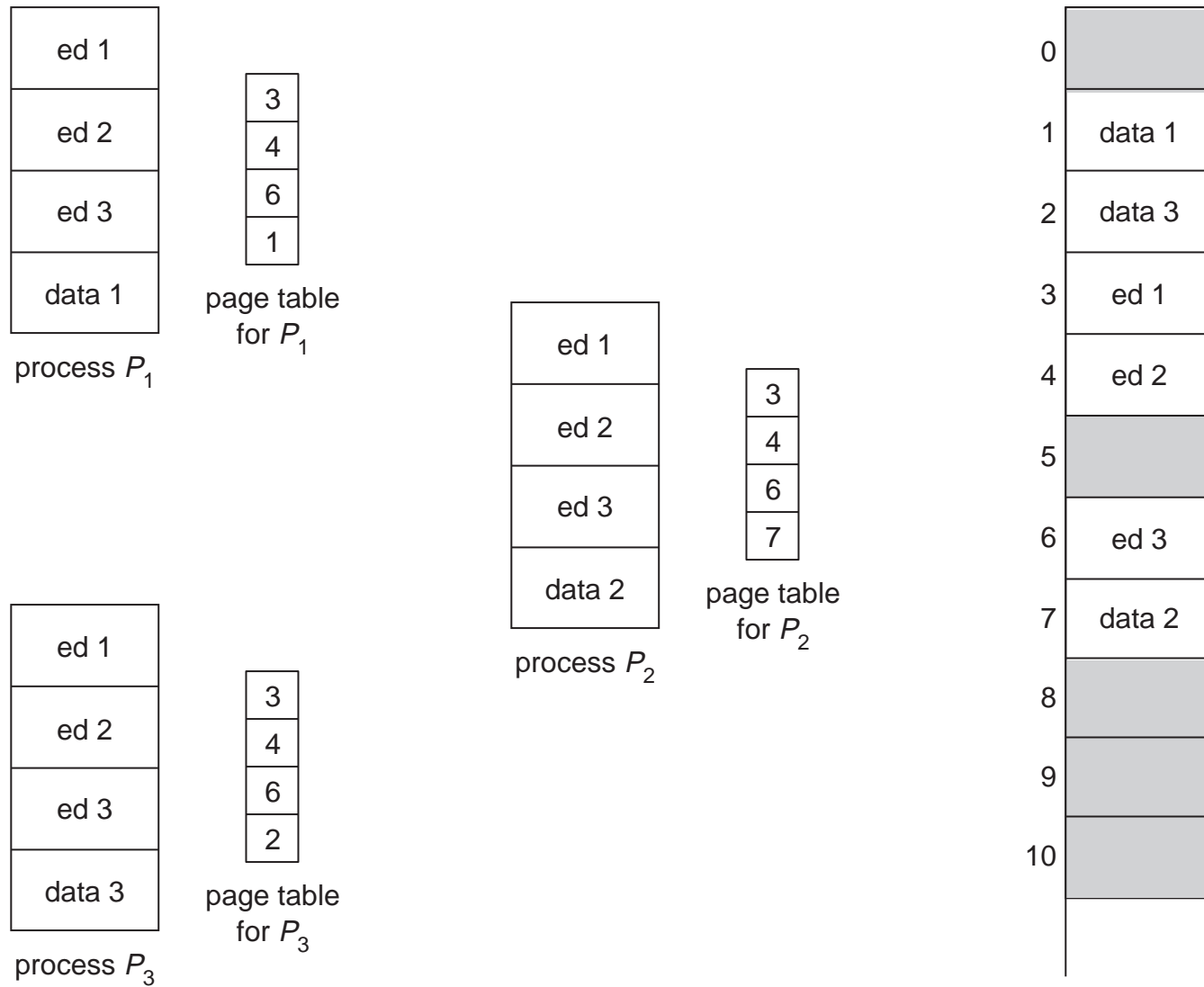

Segmentation

- Memory-management scheme that supports user view of memory.
- A program is a collection of segments. A segment is a logical unit such as:

main program,
procedure,
function,
local variables, global variables,
common block,
stack,
symbol table, arrays

Logical View of Segmentation

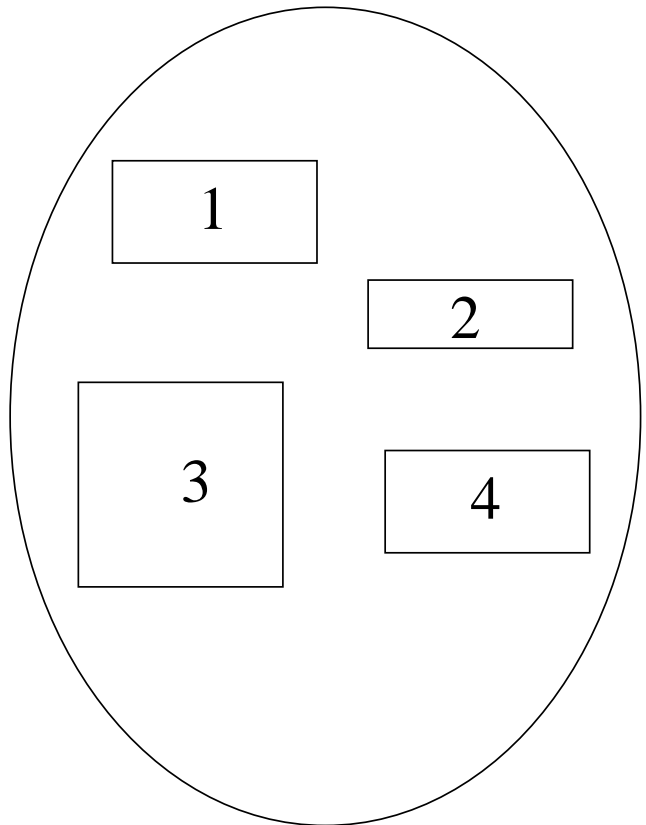

user space

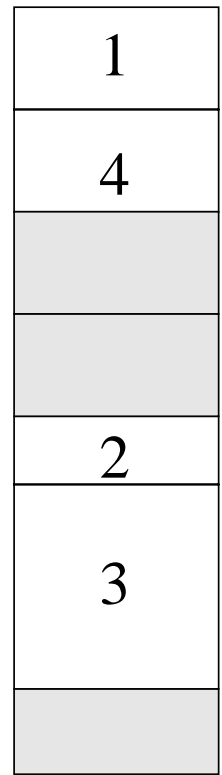

physical memory

Segmentation Architecture

- Logical address consists of a two tuple:
 $\langle \text{segment-number, offset} \rangle$.
- *Segment table* – maps two-dimensional user-defined addresses into one-dimensional physical addresses; each table entry has:
 - *base* – contains the starting physical address where the segments reside in memory.
 - *limit* – specifies the length of the segment.
- *Segment-table base register* (STBR) points to the segment table's location in memory.
- *Segment-table length register* (STLR) indicates number of segments used by a program;
 segment number s is legal if $s < \text{STLR}$.

Segmentation Architecture (Cont.)

- Relocation.
 - dynamic
 - by segment table
- Sharing.
 - shared segments
 - same segment number
- Allocation.
 - first fit/best fit
 - external fragmentation

Segmentation Architecture (Cont.)

- Protection. With each entry in segment table associate:
 - validation bit = 0 \Rightarrow illegal segment
 - read/write/execute privileges
- Protection bits associated with segments; code sharing occurs at segment level.
- Since segments vary in length, memory allocation is a dynamic storage-allocation problem.
- A segmentation example is shown in the following diagram

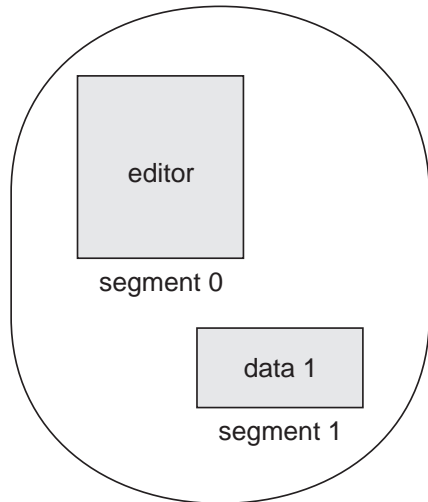

logical memory
process P_1

	limit	base
0	25286	43062
1	4425	68348

segment table
process P_1

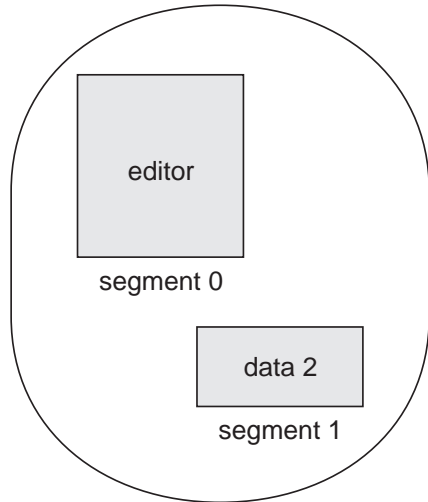

logical memory
process P_2

	limit	base
0	25286	43062
1	8850	90003

segment table
process P_2

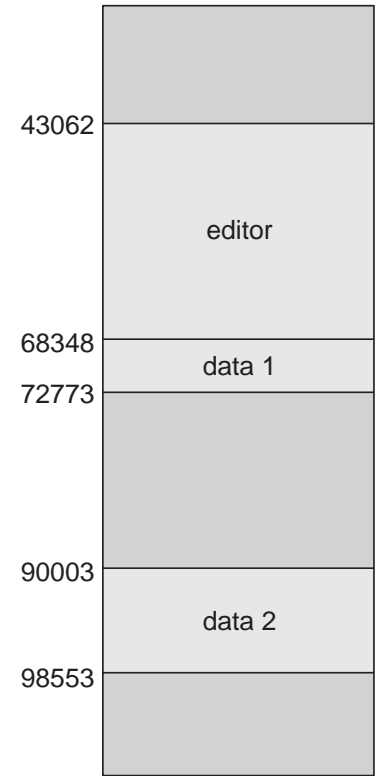

physical memory

Segmentation with Paging – MULTICS

- The MULTICS system solved problems of external fragmentation and lengthy search times by paging the segments.
- Solution differs from pure segmentation in that the segment-table entry contains not the base address of the segment, but rather the base address of a *page table* for this segment.

MULTICS Address Translation Scheme

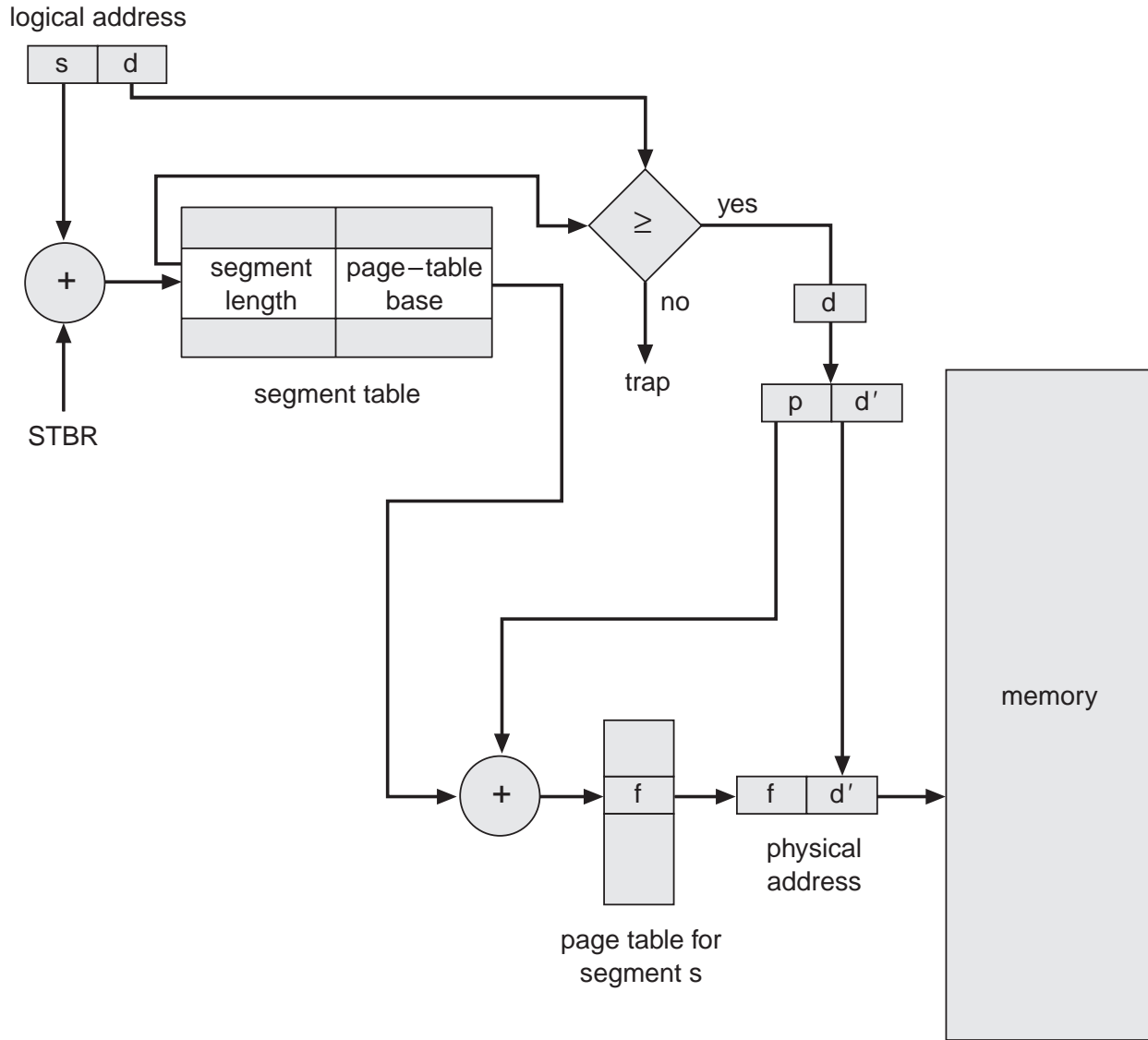

Segmentation with Paging – Intel 386

- As shown in the following diagram, the Intel 386 uses segmentation with paging for memory management, with a two-level paging scheme.

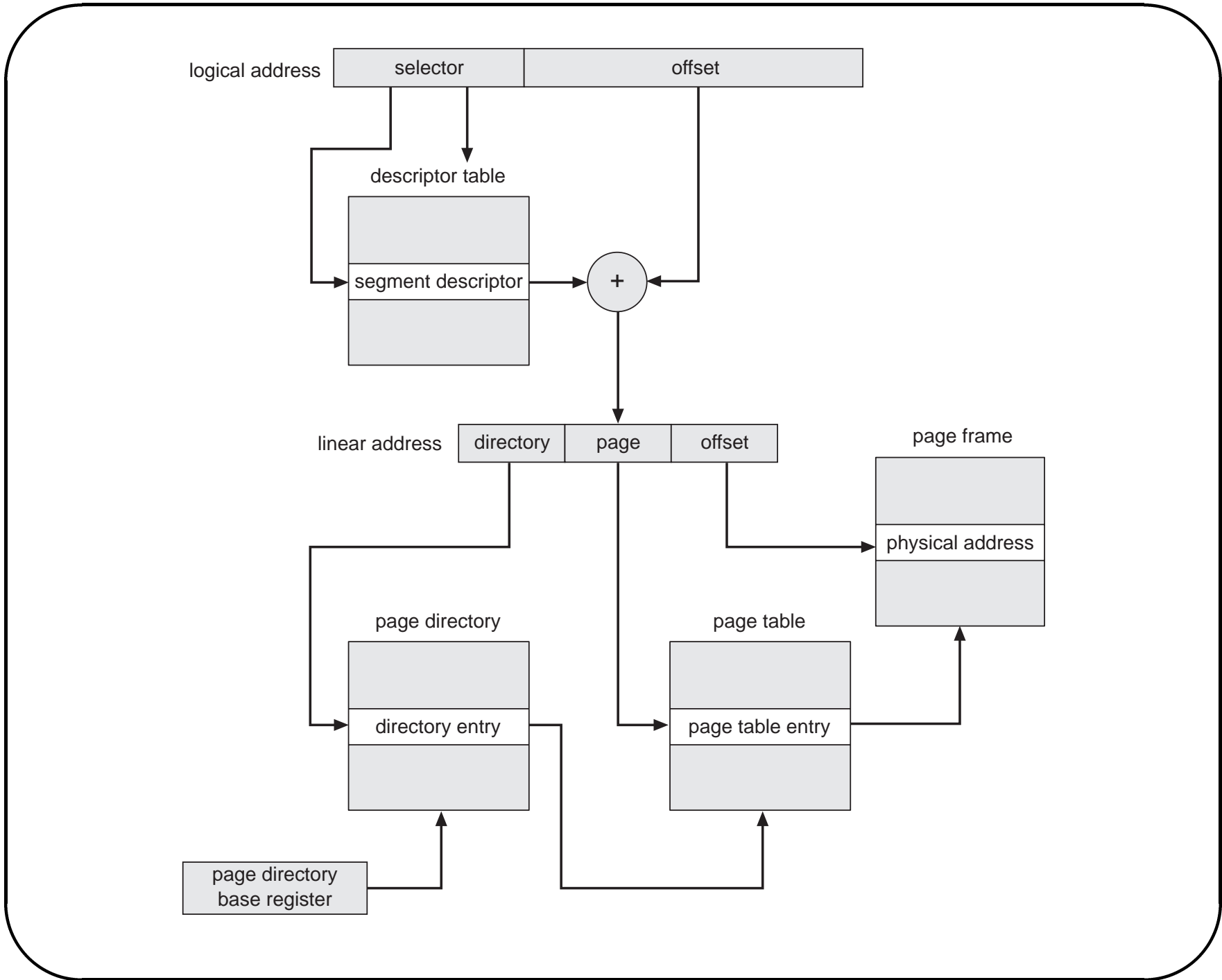

Comparing Memory-Management Strategies

- Hardware support
- Performance
- Fragmentation
- Relocation
- Swapping
- Sharing
- Protection