

Constraint Satisfaction

Russell & Norvig Ch. 6

Overview

- Constraint satisfaction is a powerful problem-solving paradigm
 - Problem: **set of variables** to which we must assign **values** satisfying **problem-specific constraints**
 - Constraint programming, constraint satisfaction problems (CSPs), constraint logic programming...
- Algorithms for CSPs
 - Backtracking (systematic search)
 - Constraint propagation (k-consistency)
 - Variable and value ordering heuristics
 - Backjumping and dependency-directed backtracking

Motivating example: 8 Queens

Place 8 queens on a chess board such
That none is attacking another.

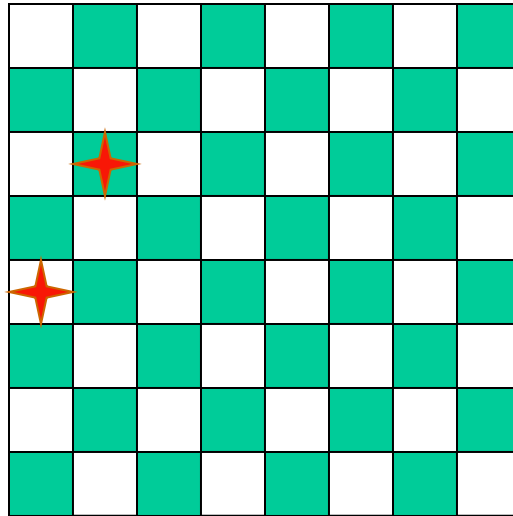

Generate-and-test, with no
redundancies → “only” 8^8 combinations

$8^{**}8$ is 16,777,216

Motivating example: 8-Queens

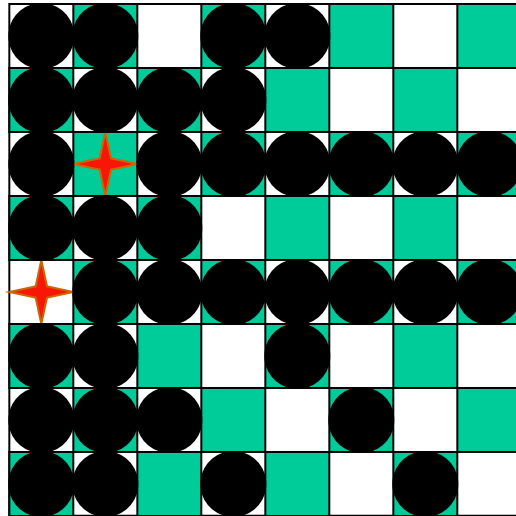

After placing these two queens, it's trivial to mark the squares we can no longer use

What more do we need for 8 queens?

- Not just a successor function and goal test
- But also
 - a means to propagate constraints imposed by one queen on others
 - an early failure test
- Explicit representation of constraints and constraint manipulation algorithms

Informal definition of CSP

- **CSP** ([Constraint Satisfaction Problem](#)), given
 - (1) finite set of variables
 - (2) each with domain of possible values (often finite)
 - (3) set of constraints limiting values variables can take
- **Solution:** assignment of a value to each variable such that all constraints are satisfied
- **Possible tasks:** decide if solution exists, find a solution, find all solutions, find *best solution* according to some metric (objective function)

Example: 8-Queens Problem

- What are the variables?
- What are the variables domains, i.e., sets of possible values
- What are the constraints between (pairs of) variables?

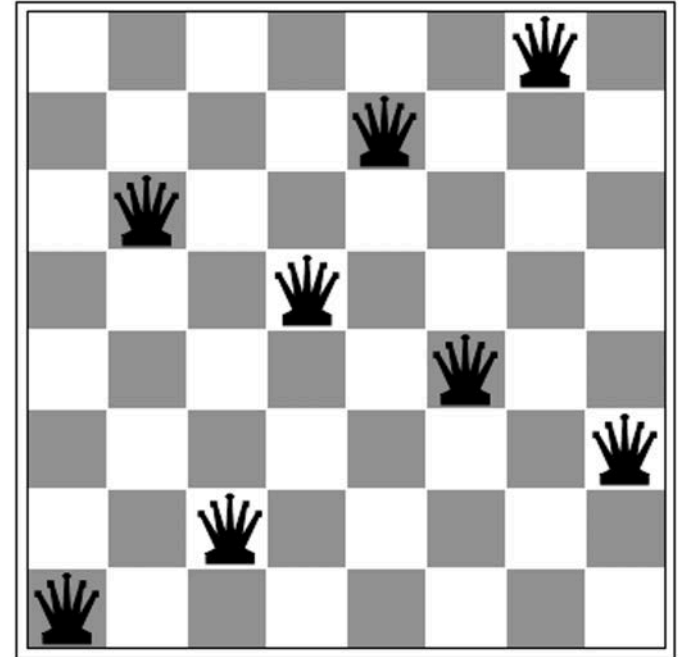

Example: 8-Queens Problem

- Eight variables Q_i , $i = 1..8$ where Q_i is the row number of queen in column i
- Domain for each variable $\{1,2,\dots,8\}$
- Constraints are of the forms:
 - No queens on same row
 $Q_i = k \rightarrow Q_j \neq k$ for $j = 1..8, j \neq i$
 - No queens on same diagonal
 $Q_i = \text{row}_i, Q_j = \text{row}_j \rightarrow |i-j| \neq |\text{row}_i - \text{row}_j|$ for $j = 1..8, j \neq i$

Example: Map coloring

Color this map using three colors (red, green, blue) such that no two adjacent regions have the same color

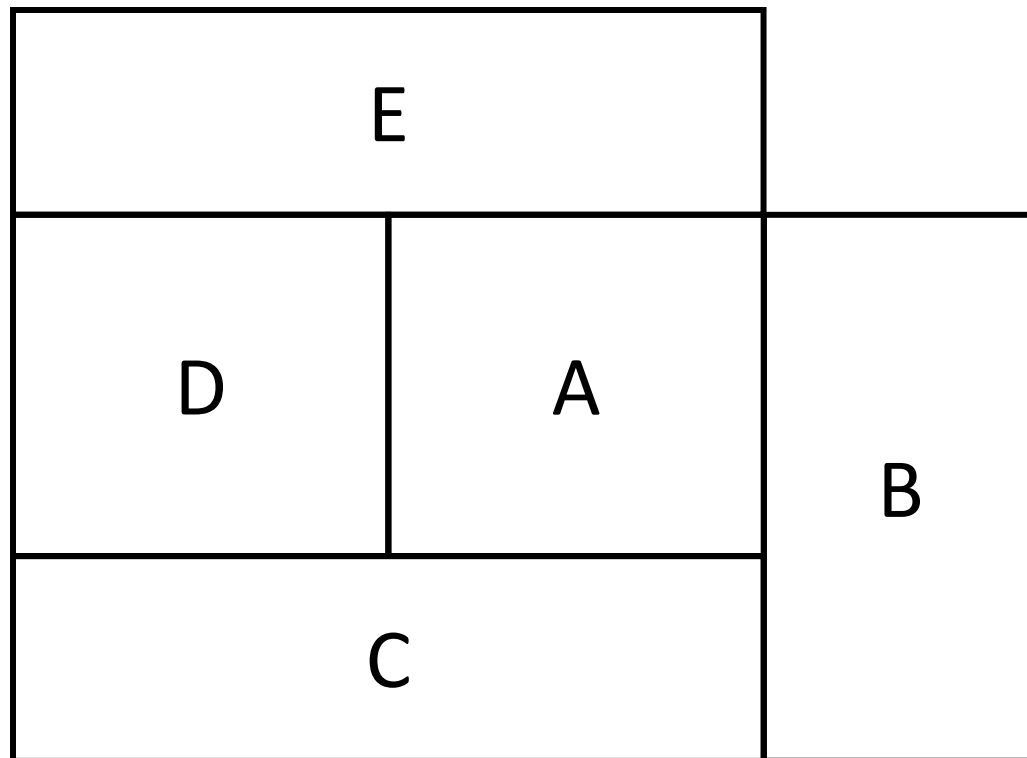

Map coloring

- **Variables:** A, B, C, D, E all of domain RGB
 - **Domains:** RGB = {red, green, blue}
 - **Constraints:** $A \neq B$, $A \neq C$, $A \neq E$, $A \neq D$, $B \neq C$, $C \neq D$, $D \neq E$
-
- A solution: A=red, B=green, C=blue, D=green, E=blue

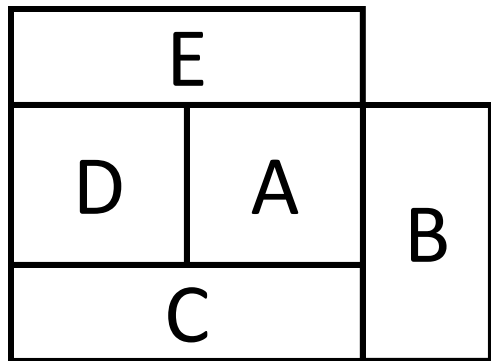

=>

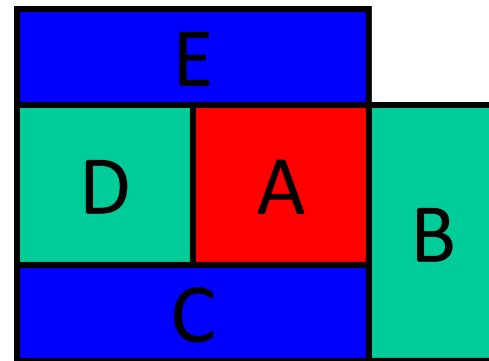

Brute Force methods

- Finding a solution by a brute force search is easy
 - Generate and test is a *weak method*
 - Just generate potential combinations and test each
- Potentially very inefficient
 - With n variables where each can have one of 3 values, there are 3^n possible solutions to check
- There are ~190 countries in the world, which we can color using four colors
- 4^{190} is a big number!

```
solve(A,B,C,D,E) :-  
  color(A),  
  color(B),  
  color(C),  
  color(D),  
  color(E),  
  not(A=B),  
  not(A=B),  
  not(B=C),  
  not(A=C),  
  not(C=D),  
  not(A=E),  
  not(C=D).  
  
color(red).  
color(green).  
color(blue).
```

generate

test

Example: Boolean SATisfiability

- Given a set of logic propositions, find an assignment of the variables to {true, false} that makes them all true (i.e., satisfies them)
- For example, the two clauses:
 - $(A \vee B \vee \neg C)$
 - $(\neg A \vee D)$are both made true (i.e. satisfied) by assigning
A = false, B = true, C = false, D = false
- Satisfiability known to be NP-complete
⇒ worst case, solving CSP problems requires exponential time

Real-world problems

CSPs are a good match for many practical problems that arise in the real world

- Scheduling
- Temporal reasoning
- Building design
- Planning
- Optimization/satisfaction
- Vision
- Graph layout
- Network management
- Natural language processing
- Molecular biology / genomics
- VLSI design

Running example: coloring Australia

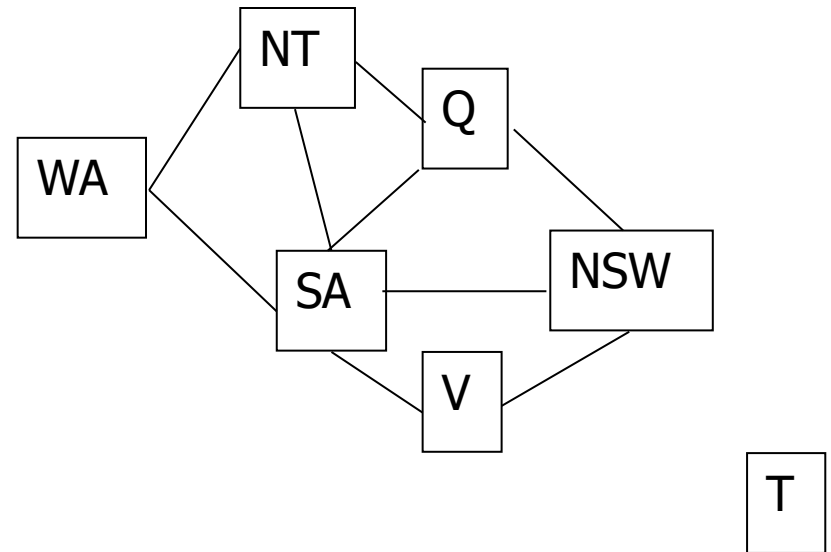
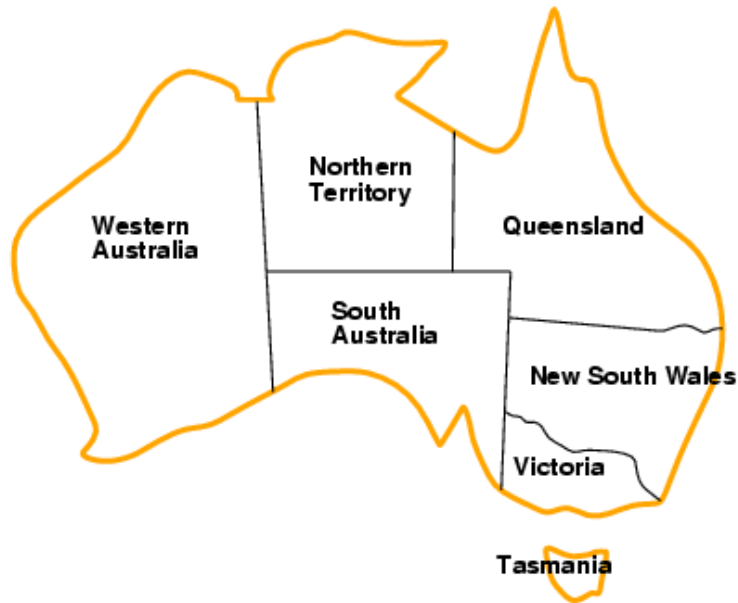

- Seven variables: {WA, NT, SA, Q, NSW, V, T}
- Each variable has same domain: {red, green, blue}
- No two adjacent variables can have same value:
 $WA \neq NT$, $WA \neq SA$, $NT \neq SA$, $NT \neq Q$, $SA \neq Q$, $SA \neq NSW$,
 $SA \neq V$, $Q \neq NSW$, $NSW \neq V$

Unary & binary constraints most common

Binary constraints

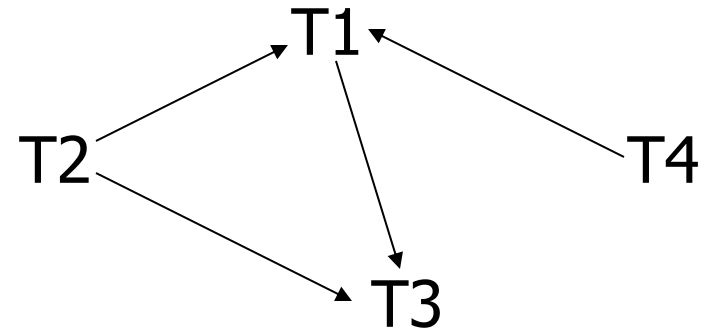
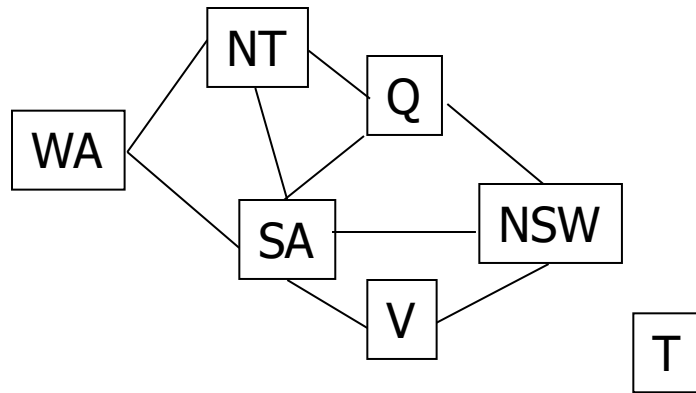

- Two variables are adjacent or neighbors if connected by an edge or an arc
- Possible to rewrite problems with higher-order constraints as ones with just binary constraints

Formal definition of a CN

- Instantiations
 - An **instantiation** of a subset of variables S is an assignment of a value (in its domain) to each variable in S
 - An instantiation is **legal** iff it violates no constraints
- A **solution** is a legal instantiation of all variables in the network

Typical tasks for CSP

- Possible solution related tasks:
 - Does a solution exist?
 - Find one solution
 - Find all solutions
 - Given a metric on solutions, find best one
 - Given a partial instantiation, do any of above
- Transform the constraint network into an equivalent one that's easier to solve

Binary CSP

- A **binary CSP** is one where all constraints involve two variables (or just one variable)
- Any non-binary CSP can be converted into a binary CSP by introducing additional variables
- Binary CSPs represented as a **constraint graph**, with a node for each variable and an arc between two nodes iff there's a constraint involving them
 - Unary constraints appear as self-referential arcs

Running example: coloring Australia

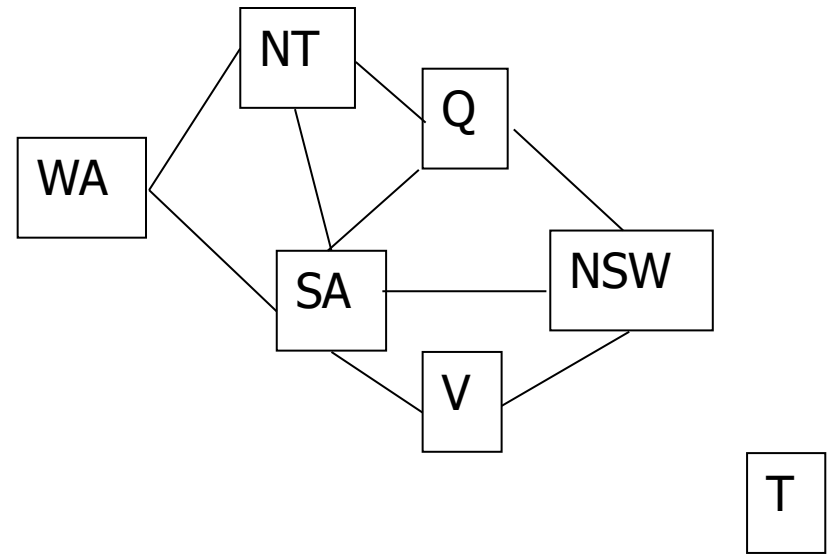

- Seven variables: {WA, NT, SA, Q, NSW, V, T}
- Each variable has same domain: {red, green, blue}
- No two adjacent variables can have same value:
 $WA \neq NT$, $WA \neq SA$, $NT \neq SA$, $NT \neq Q$, $SA \neq Q$, $SA \neq NSW$,
 $SA \neq V$, $Q \neq NSW$, $NSW \neq V$

A running example: coloring Australia

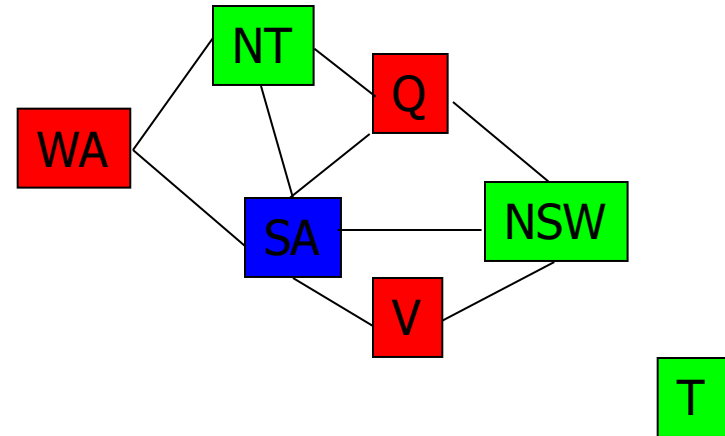
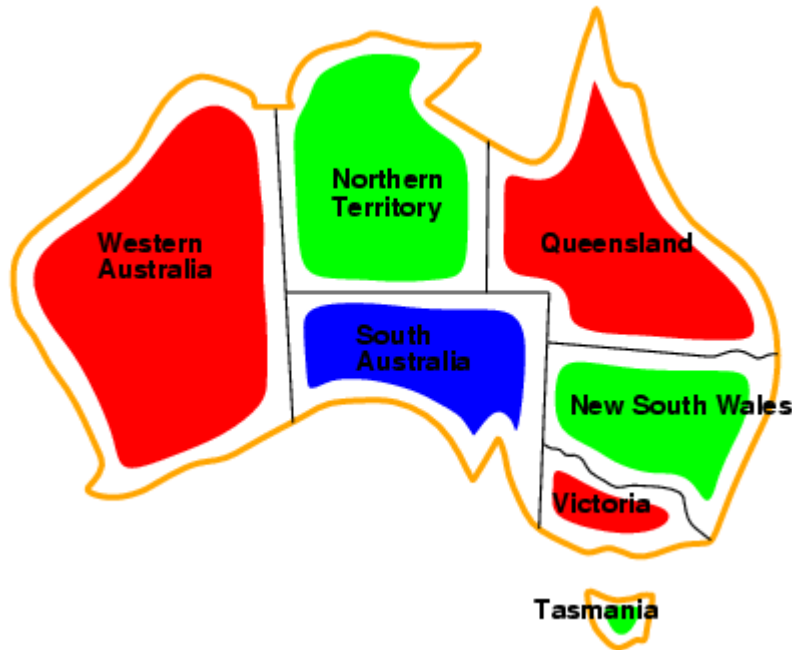

- Solutions: complete & consistent assignments
- Here is one of several solutions
- For generality, constraints can be expressed as relations, e.g., describe $WA \neq NT$ as $\{(red,green), (red,blue), (green,red), (green,blue), (blue,red),(blue,green)\}$

Backtracking example



Backtracking example

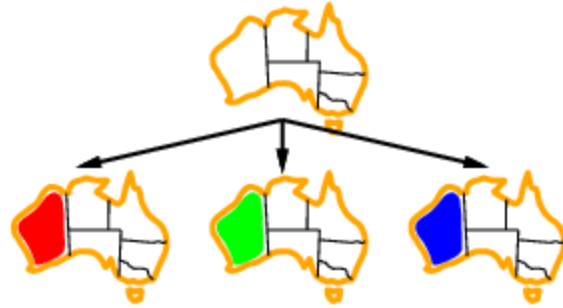

Backtracking example

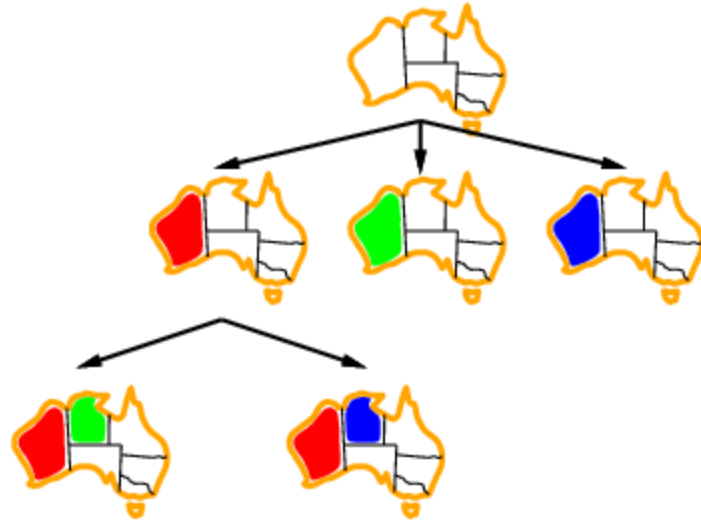

Backtracking example

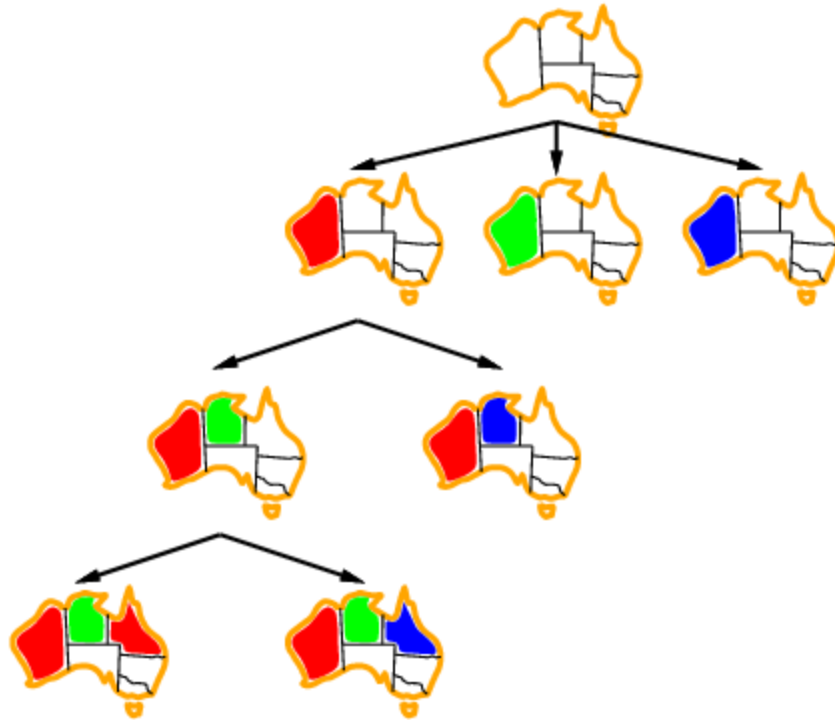

CSP-backtracking(PartialAssignment A)

- If A is complete then return a
- $X \leftarrow$ select an unassigned variable
- $D \leftarrow$ select an ordering for the domain of X
- For each value v in D do
 - If v consistent with a then
 - Add (X=v) to A
 - result \leftarrow CSP-BACKTRACKING(A)
 - If result \neq failure then return result
 - Remove (X= v) from A
- Return failure

Start with CSP-BACKTRACKING({})

Note: depth first search can solve n-queens problems for $n \sim 25$

Basic backtracking algorithm

Problems with Backtracking

- Thrashing: keep repeating the same failed variable assignments
- Things that can help avoid this:
 - Consistency checking
 - Intelligent backtracking schemes
- Inefficiency: can explore areas of the search space that aren't likely to succeed
 - Variable ordering can help

Improving backtracking efficiency

Here are some standard techniques to improve the efficiency of backtracking

- Can we detect inevitable failure early?
- Which variable should be assigned next?
- In what order should its values be tried?

Forward Checking

After variable X is assigned to value v , examine each unassigned variable Y connected to X by a constraint and delete values from Y 's domain inconsistent with v

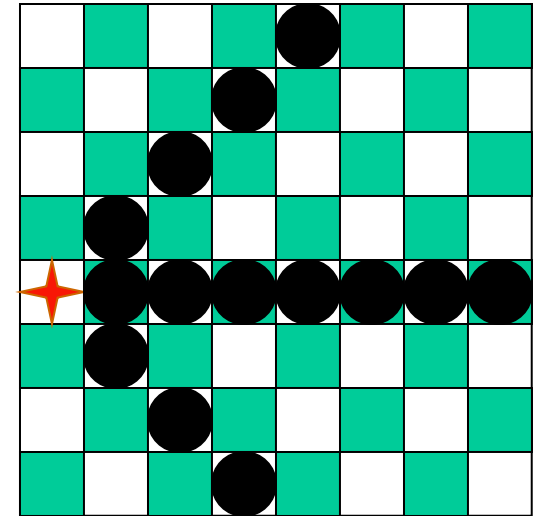

Using forward checking and backward checking roughly doubles the size of N-queens problems that can be practically solved

Forward checking



- Keep track of remaining legal values for unassigned variables
- Terminate search when any variable has no legal values

Forward checking



Forward checking



WA	NT	Q	NSW	V	SA	T
Red	Green	Blue	Red	Green	Blue	Red
Red	Green	Blue	Red	Green	Blue	Red
Red	Blue	Green	Red	Green	Blue	Red

Forward checking



WA

NT

Q

NSW

V

SA

T

Red	Green	Blue					
Red	Green	Blue	Red	Green	Blue		
Red		Blue	Green	Red	Green	Blue	Red
Red		Blue	Green	Red	Blue		Red

SA (South Australia)
domain is empty!

Constraint propagation

- Forward checking propagates info. from assigned to unassigned variables, but doesn't provide early detection for all failures
- NT and SA cannot both be blue!

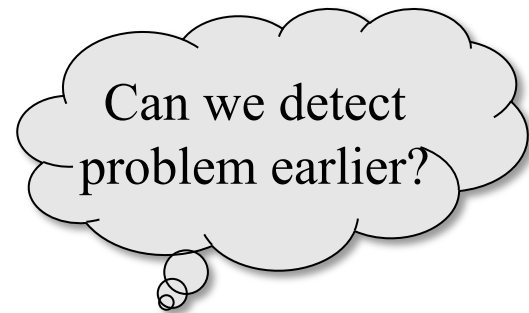

Definition: Arc consistency

- A constraint C_{xy} is arc consistent w.r.t. x if for each value v of x there is an allowed value of y
- Similarly define C_{xy} as arc consistent w.r.t. y
- Binary CSP is arc consistent iff **every** constraint C_{xy} is arc consistent w.r.t. x as well as y
- When a CSP is not arc consistent, we can make it arc consistent by using the AC3 algorithm
 - Also called “enforcing arc consistency”

Arc Consistency Example 1

- Domains

- $D_x = \{1, 2, 3\}$

- $D_y = \{3, 4, 5, 6\}$

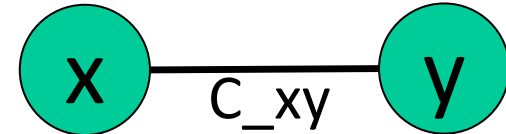

- Constraint

- Note: for finite domains, we can represent a constraint as a set of legal value pairs

- $C_{xy} = \{(1,3), (1,5), (3,3), (3,6)\}$

- C_{xy} isn't arc consistent w.r.t. x or y

- Enforcing arc consistency, we get reduced domains:

- $D'_x = \{1, 3\}$

- $D'_y = \{3, 5, 6\}$

Arc Consistency Example 2

- Domains

- $D_x = \{1, 2, 3\}$

- $D_y = \{1, 2, 3\}$

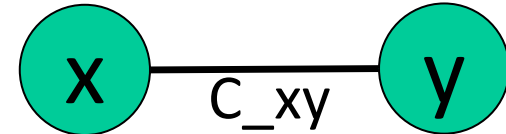

- Constraint: X must be less than Y

- $C_{xy} = \lambda v_1, v_2 : v_1 < v_2$

- C_{xy} not arc consistent w.r.t. x or y; enforcing arc consistency, we get reduced domains:

- $D'_x = \{1, 2\}$

- $D'_y = \{2, 3\}$

Aside: Python lambda expressions

Previous slide expressed constraint between two variables as an *anonymous* Python function of two arguments

```
lambda v1,v2: v1 < v2
```

```
>>> f = lambda v1,v2: v1 < v2
>>> f
<function <lambda> at 0x10fcf21e0>
>>> f(100,200)
True
>>> f(200,100)
False
```

*Python uses
lambda after
Alonzo Church's
[lambda calculus](#)
from the 1930s*

Arc consistency



- Simplest form of propagation makes each arc consistent
- $X \rightarrow Y$ is consistent iff for every value x_i of X there is some allowed value y_j in Y

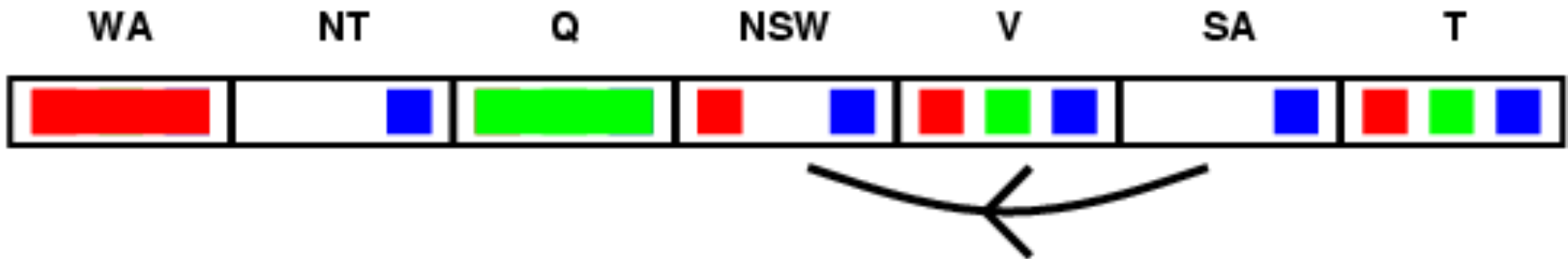

Arc consistency



- Simplest form of propagation makes each arc consistent
- $X \rightarrow Y$ is consistent iff for every value x_i of X there is some allowed value y_j in Y

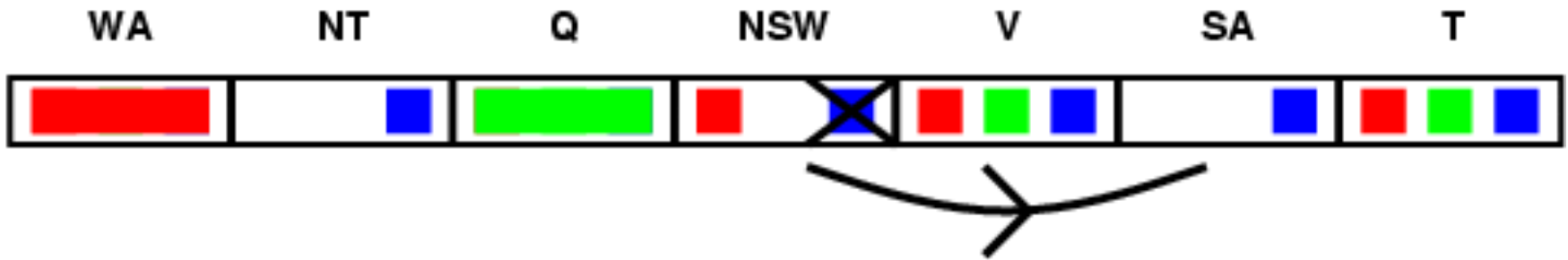

Arc consistency



- Arc consistency detects failure earlier than simple forward checking
- WA=red and Q=green is quickly recognized as a **deadend**, i.e. an impossible partial instantiation
- The arc consistency algorithm can be run as a preprocessor or after each assignment

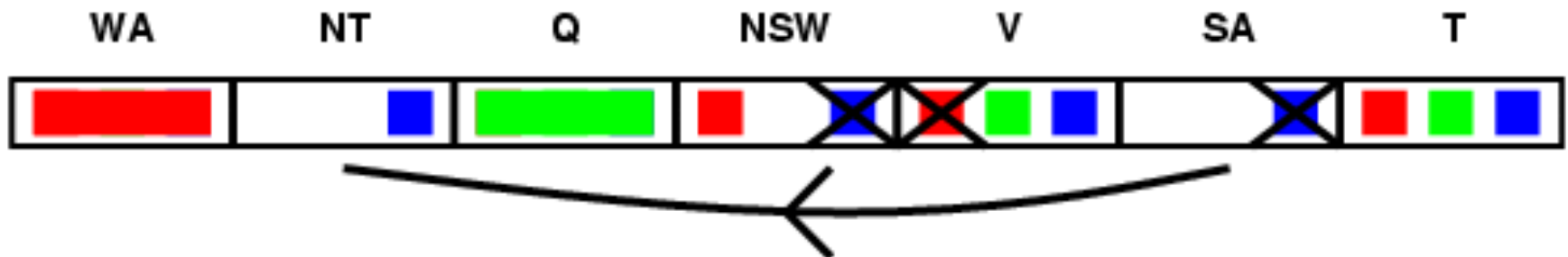

General CP for Binary Constraints

Algorithm [AC3](#)

contradiction \leftarrow false

Q \leftarrow stack of all variables

while Q is not empty and not contradiction do

 X \leftarrow UNSTACK(Q)

 For every variable Y adjacent to X do

 If REMOVE-ARC-INCONSISTENCIES(X,Y)

 If domain(Y) is non-empty then STACK(Y,Q)

 else return false

Complexity of AC3

- e = number of constraints (edges)
- d = number of values per variable
- Each variable inserted in queue up to d times
- REMOVE-ARC-INCONSISTENCY takes $O(d^2)$ time
- CP takes $O(ed^3)$ time

Improving backtracking efficiency

- Some standard techniques to improve the efficiency of backtracking
 - Can we detect inevitable failure early?
 - Which variable should be assigned next?
 - In what order should its values be tried?
- Combining constraint propagation with these heuristics makes 1000-queen puzzles feasible

H1: pick var with fewest values



- AKA most constrained variable:
choose the variable with the fewest legal values

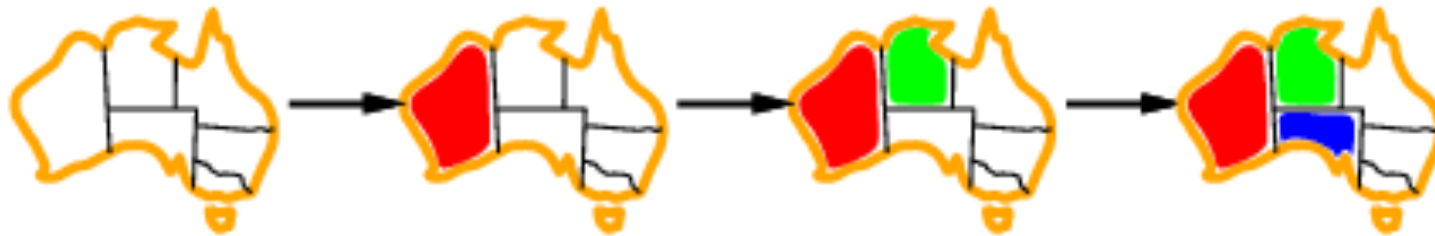

- a.k.a. minimum remaining values (MRV) heuristic
- After assigning value to WA, both NT and SA have only two values in their domains
 - choose one of them rather than Q, NSW, V or T

H2: most constraining variable

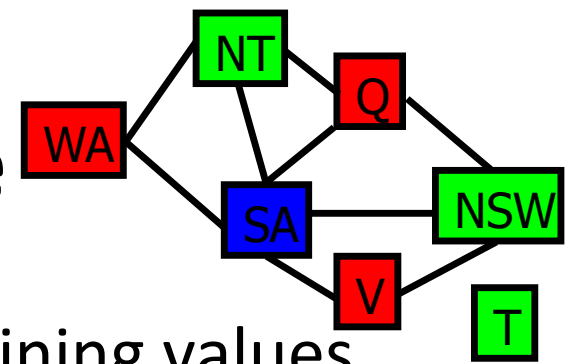

- Tie-breaker after H1, minimum remaining values
- Choose variable involved in largest # of constraints on remaining variables

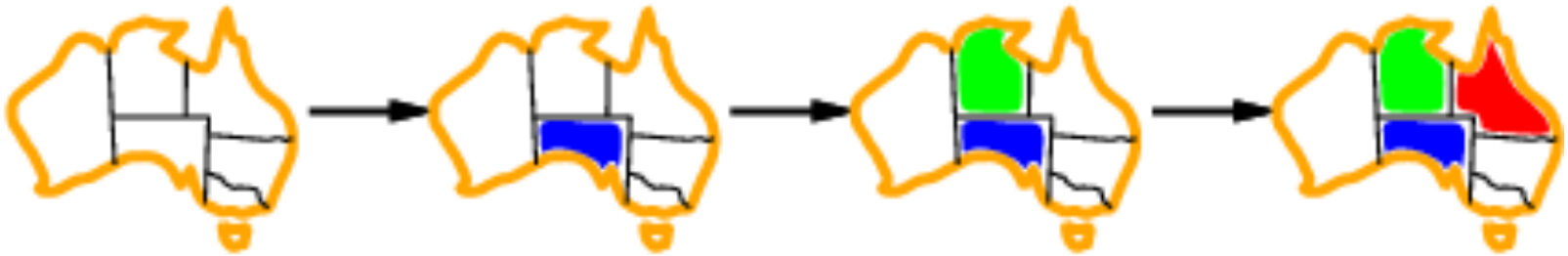

- After assigning SA to be blue, WA, NT, Q, NSW and V all have just two values left.
- WA and V have only one constraint on remaining variables and T none, so choose one of NT, Q & NSW

H3: Least constraining value

- Given variable, try value that's least constraining on its neighbors:
 - the one that rules out the fewest values in the remaining variables

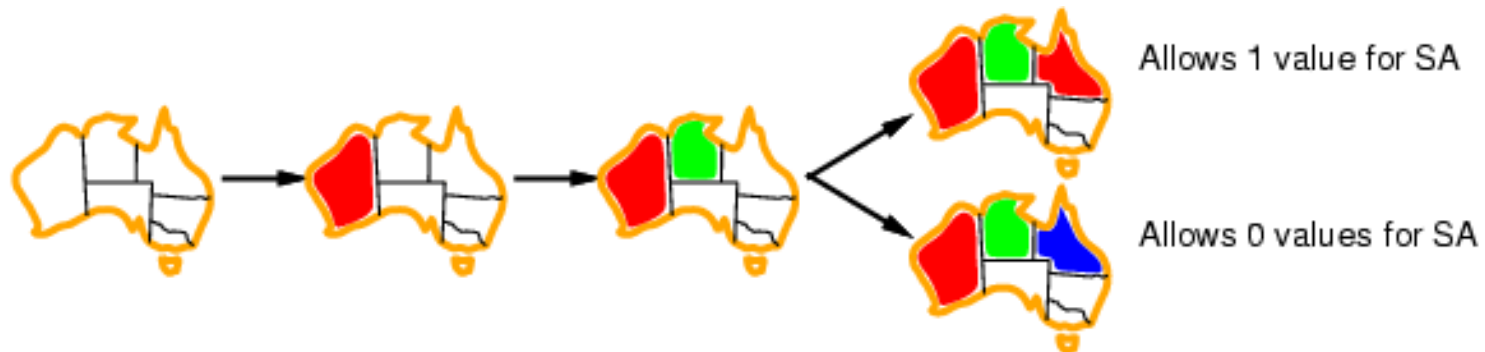

- Combining these heuristics makes 1000 queens feasible
- What's an intuitive explanation for this?

Is AC3 Alone Sufficient?

Consider the four queens problem

	1	2	3	4
1				
2				
3				
4				

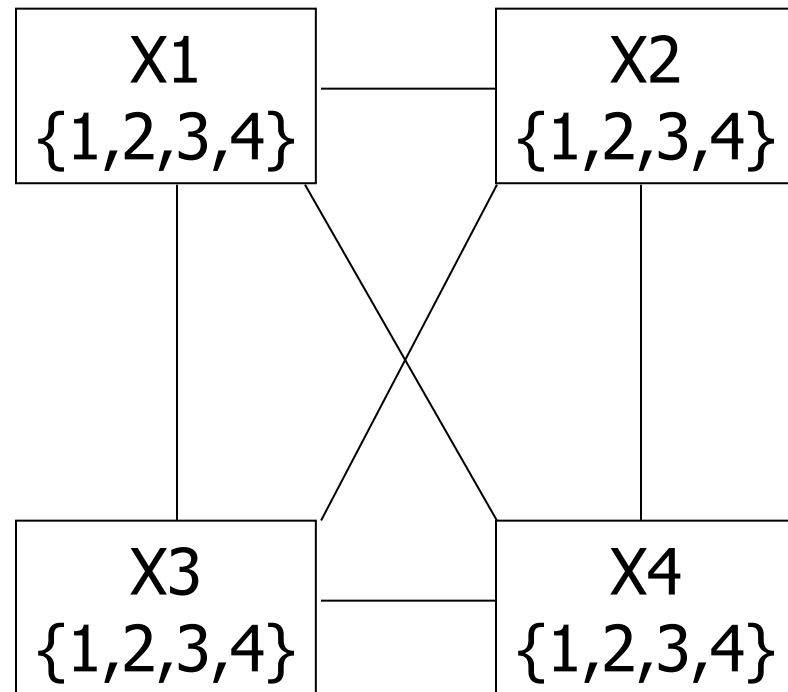

Solving a CSP still requires search

- Search:
 - can find good solutions, but must examine non-solutions along the way
- Constraint Propagation:
 - can rule out non-solutions, but this is not the same as finding solutions
- Interweave constraint propagation & search:
 - perform constraint propagation at each search step

Using Search

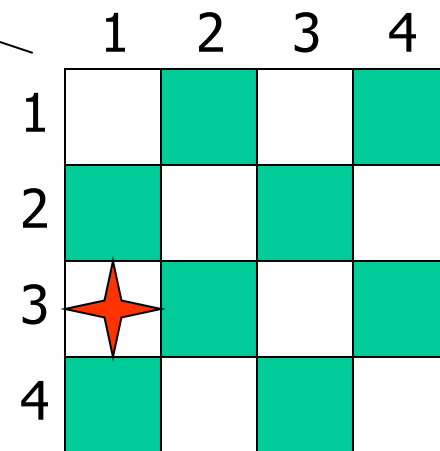
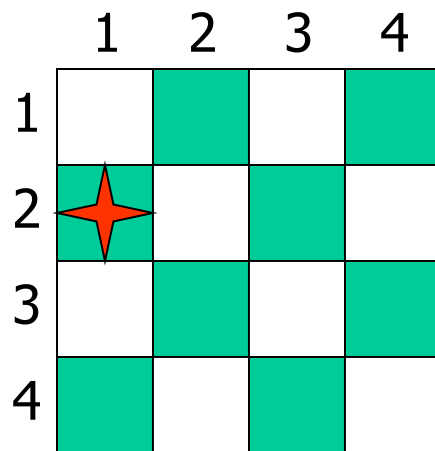
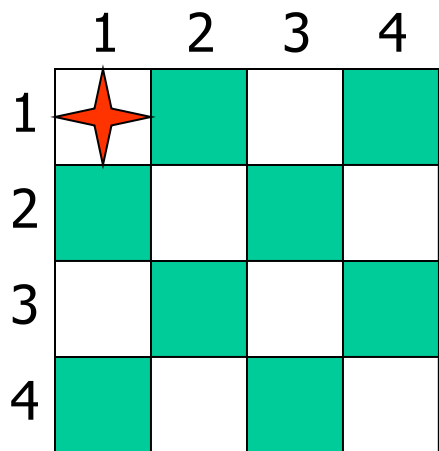
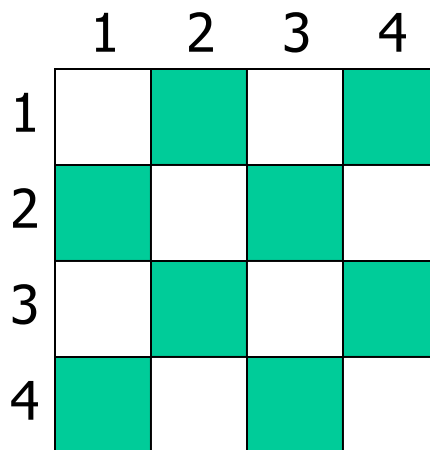

Using CSP

4-Queens Problem

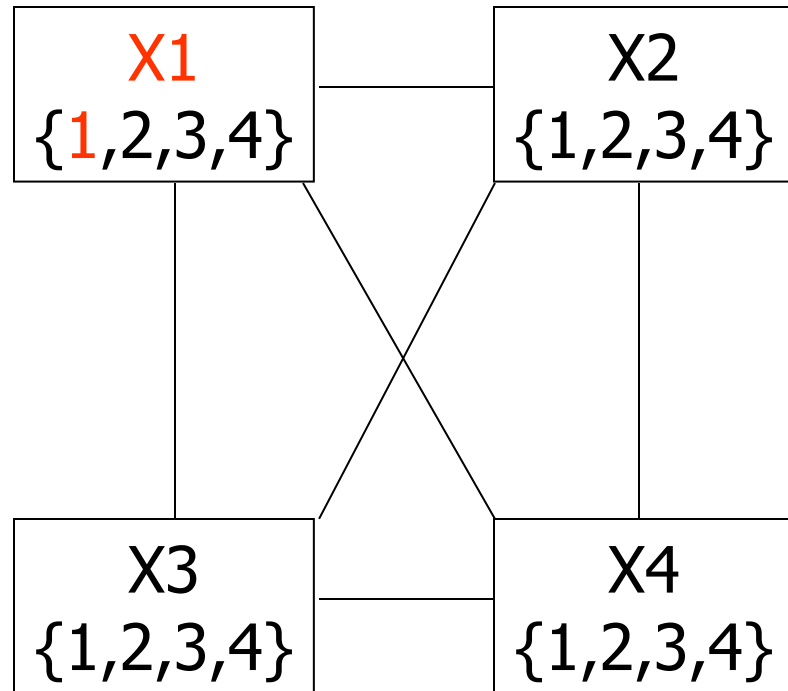
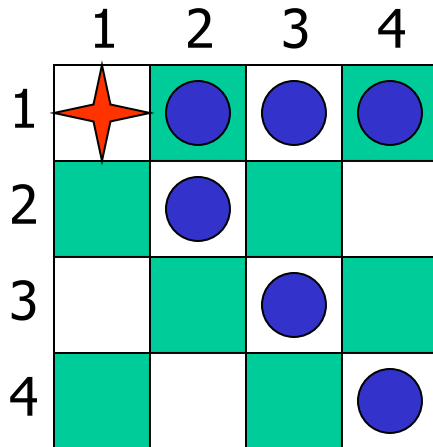

Try assigning X1=1

4-Queens Problem

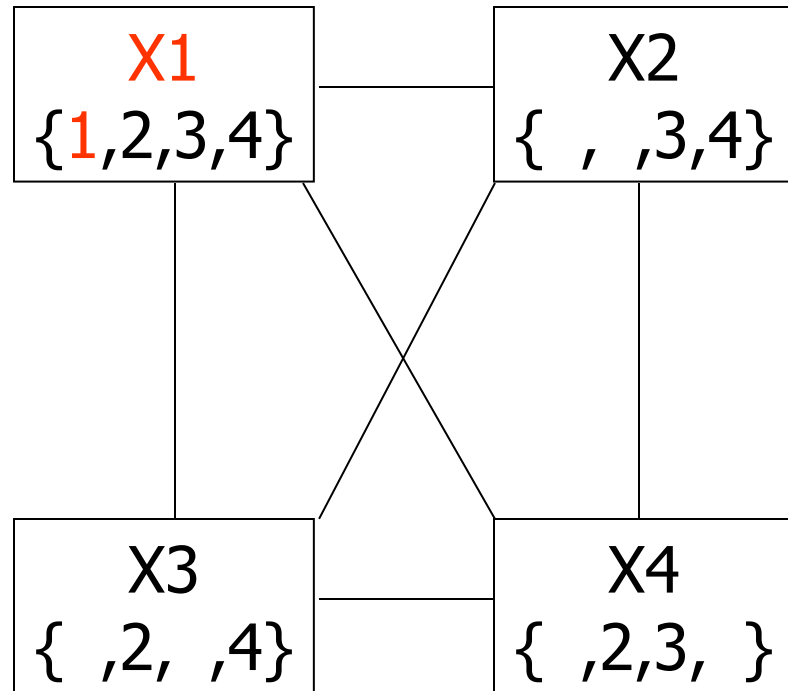
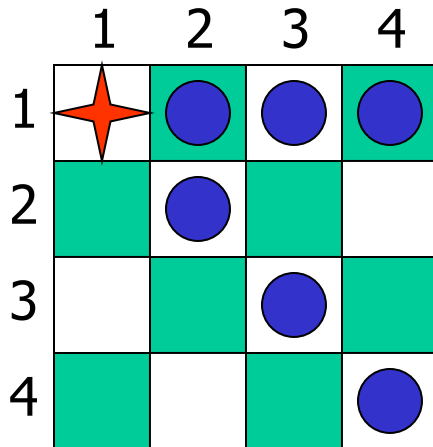

X1=1 eliminates { X2=1,2, X3=1,3, X4=1,4 }

4-Queens Problem

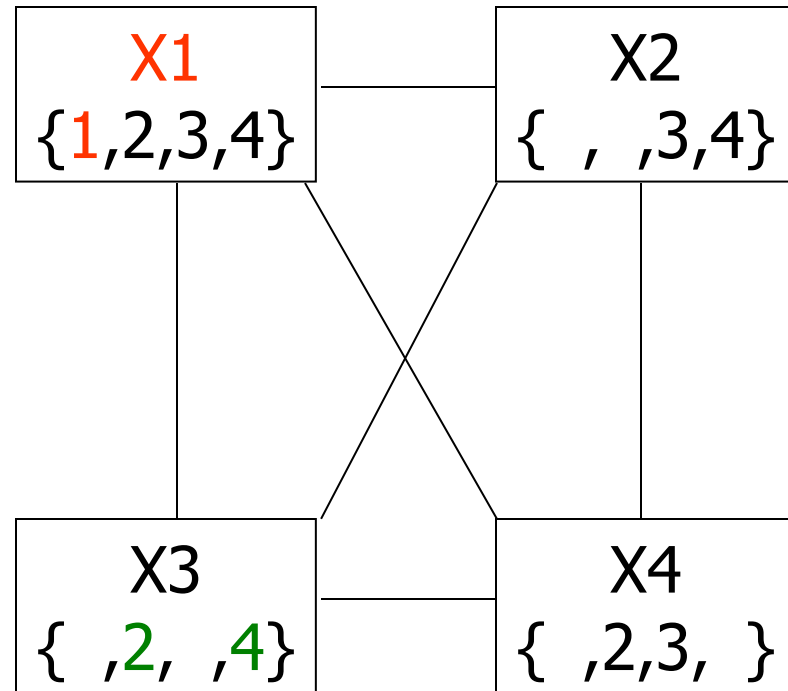
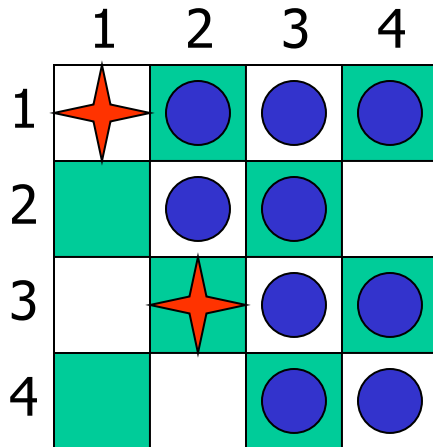

**X2=3 eliminates { X3=2, X3=3, X3=4 }
⇒ inconsistent!**

4-Queens Problem

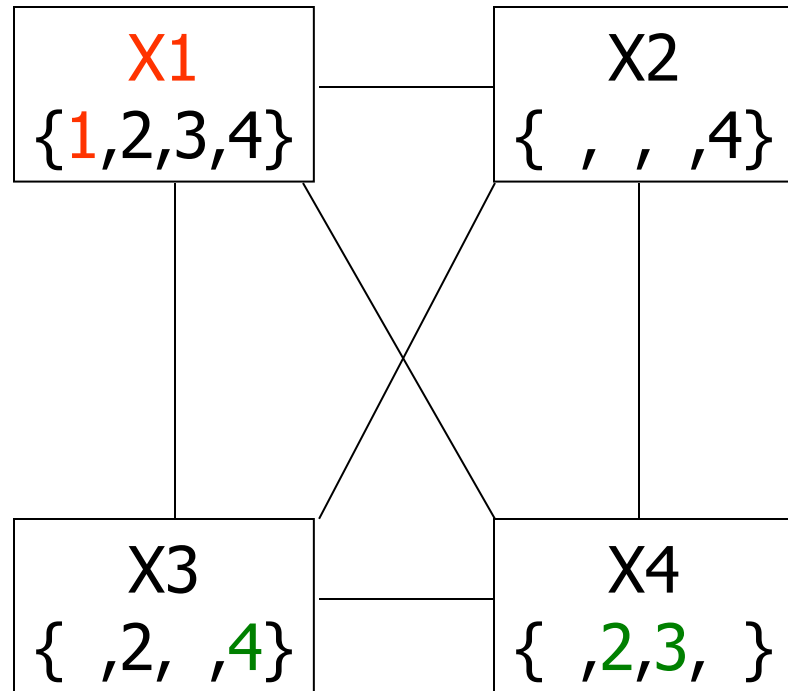
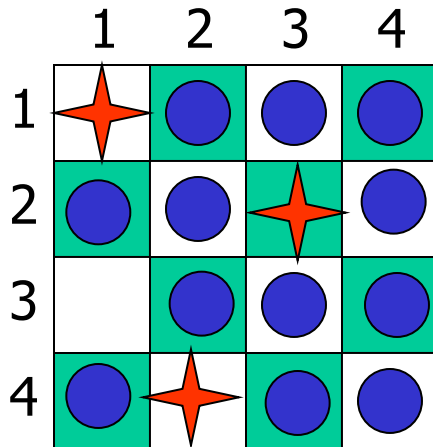

**$X2=4 \Rightarrow X3=2$, which eliminates $\{ X4=2, X4=3 \}$
 \Rightarrow inconsistent!**

4-Queens Problem

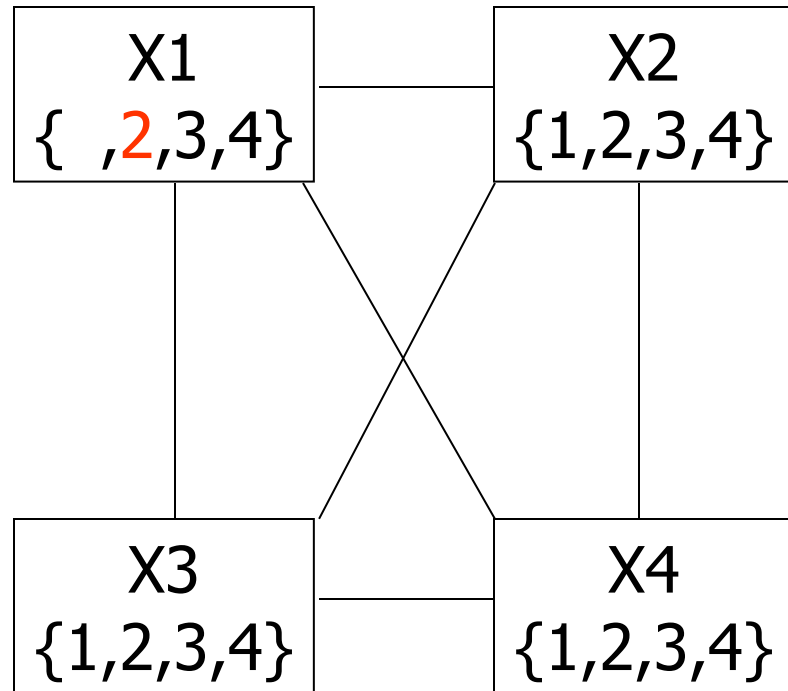
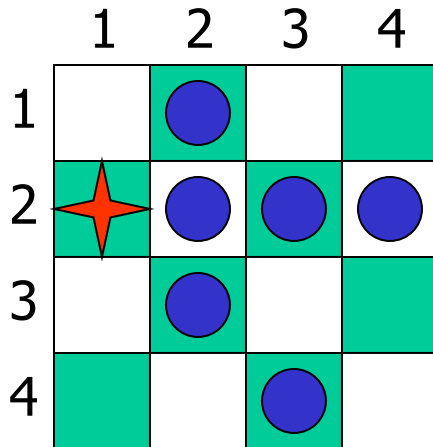

X1 can't be 1, let's try 2

4-Queens Problem

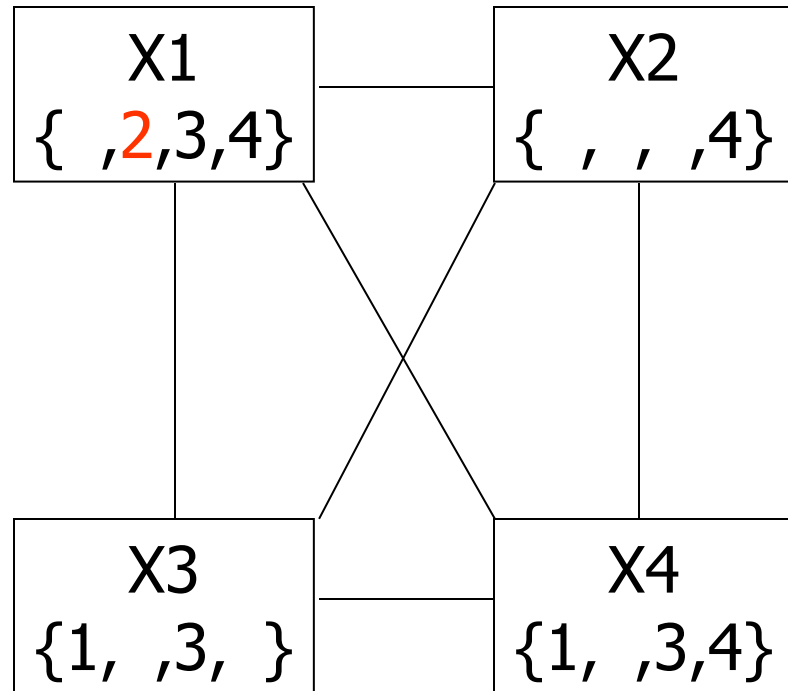
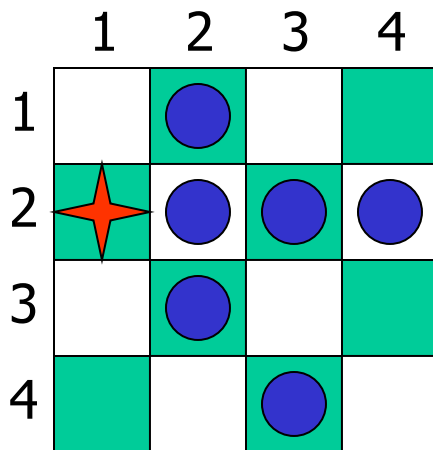

Can we eliminate any other values?

4-Queens Problem

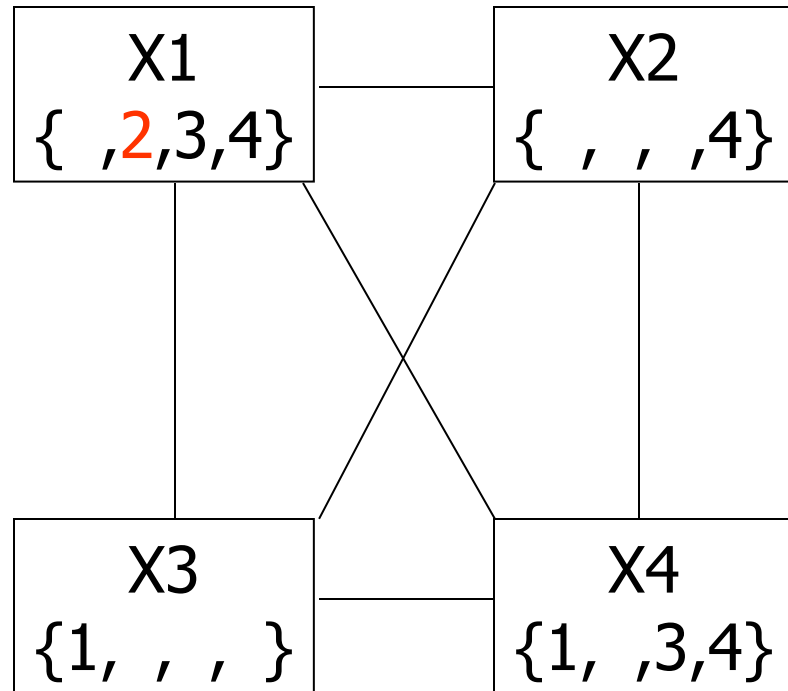
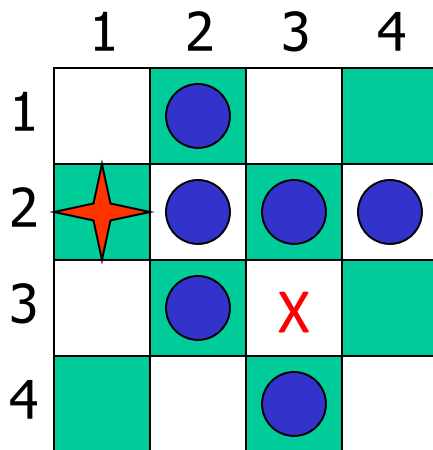

Yes! We know $X_2=4$, so X_3 can't be 3

4-Queens Problem

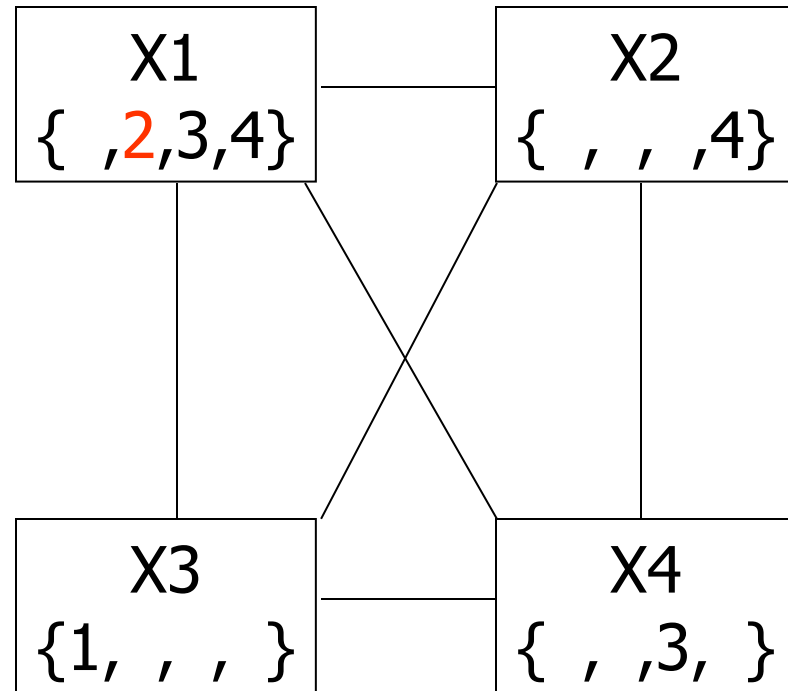
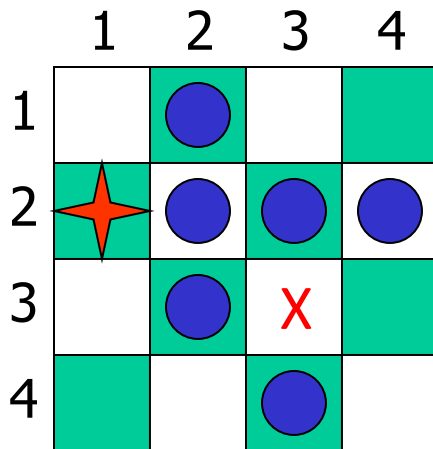

Arc constancy eliminates $x_3=3$ because it's not consistent with X2's remaining values

4-Queens Problem

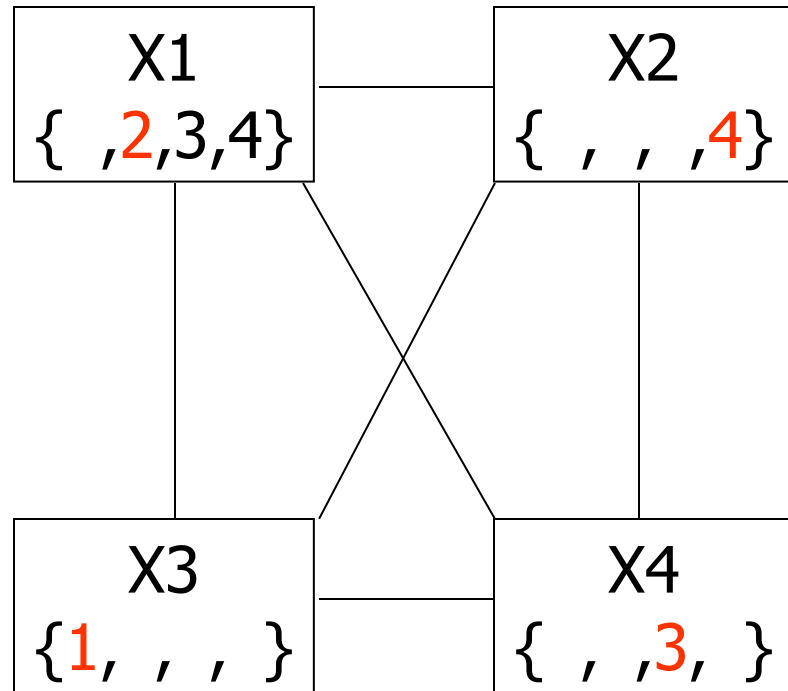
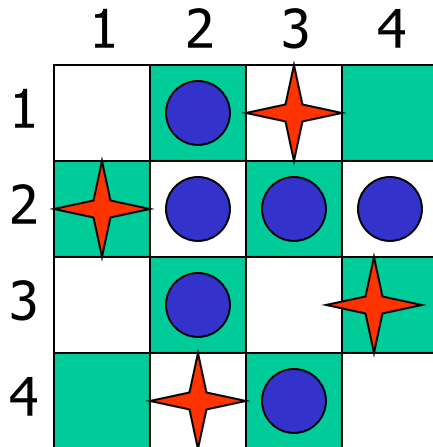

There is only one solution with $X1=2$

Sudoku

- Digit placement puzzle on 9x9 grid with unique answer
- Given an initial partially filled grid, fill remaining squares with a digit between 1 and 9
- Each column, row, and nine 3×3 sub-grids must contain all nine digits

	1	2	3	4	5	6	7	8	9
A			3		2		6		
B	9			3		5			1
C			1	8		6	4		
D			8	1		2	9		
E	7								8
F			6	7		8	2		
G			2	6		9	5		
H	8			2		3			9
I			5		1		3		

	1	2	3	4	5	6	7	8	9
A	4	8	3	9	2	1	6	5	7
B	9	6	7	3	4	5	8	2	1
C	2	5	1	8	7	6	4	9	3
D	5	4	8	1	3	2	9	7	6
E	7	2	9	5	6	4	1	3	8
F	1	3	6	7	9	8	2	4	5
G	3	7	2	6	8	9	5	1	4
H	8	1	4	2	5	3	7	6	9
I	6	9	5	4	1	7	3	8	2

- Some initial configurations are easy to solve and others very difficult

Sudoku Example

	1	2	3	4	5	6	7	8	9
A			3		2		6		
B	9			3		5			1
C			1	8		6	4		
D			8	1		2	9		
E	7								8
F			6	7		8	2		
G			2	6		9	5		
H	8			2		3			9
I			5		1		3		

initial problem

	1	2	3	4	5	6	7	8	9
A	4	8	3	9	2	1	6	5	7
B	9	6	7	3	4	5	8	2	1
C	2	5	1	8	7	6	4	9	3
D	5	4	8	1	3	2	9	7	6
E	7	2	9	5	6	4	1	3	8
F	1	3	6	7	9	8	2	4	5
G	3	7	2	6	8	9	5	1	4
H	8	1	4	2	5	3	7	6	9
I	6	9	5	4	1	7	3	8	2

a solution

How can we set this up as a CSP?

```

def sudoku(initValue):
    p = Problem()
    # Define a variable for each cell: 11,12,13...21,22,23...98,99
    for i in range(1, 10) :
        p.addVariables(range(i*10+1, i*10+10), range(1, 10))
    # Each row has different values
    for i in range(1, 10) :
        p.addConstraint(AllDifferentConstraint(), range(i*10+1, i*10+10))
    # Each column has different values
    for i in range(1, 10) :
        p.addConstraint(AllDifferentConstraint(), range(10+i, 100+i, 10))
    # Each 3x3 box has different values
    p.addConstraint(AllDifferentConstraint(), [11,12,13,21,22,23,31,32,33])
    p.addConstraint(AllDifferentConstraint(), [41,42,43,51,52,53,61,62,63])
    p.addConstraint(AllDifferentConstraint(), [71,72,73,81,82,83,91,92,93])

    p.addConstraint(AllDifferentConstraint(), [14,15,16,24,25,26,34,35,36])
    p.addConstraint(AllDifferentConstraint(), [44,45,46,54,55,56,64,65,66])
    p.addConstraint(AllDifferentConstraint(), [74,75,76,84,85,86,94,95,96])

    p.addConstraint(AllDifferentConstraint(), [17,18,19,27,28,29,37,38,39])
    p.addConstraint(AllDifferentConstraint(), [47,48,49,57,58,59,67,68,69])
    p.addConstraint(AllDifferentConstraint(), [77,78,79,87,88,89,97,98,99])

    # add unary constraints for cells with initial non-zero values
    for i in range(1, 10) :
        for j in range(1, 10):
            value = initValue[i-1][j-1]
            if value:
                p.addConstraint(lambda var, val=value: var == val, (i*10+j,))
    return p.getSolution()

```

```

# Sample problems
easy = [
    [0,9,0,7,0,0,8,6,0],
    [0,3,1,0,0,5,0,2,0],
    [8,0,6,0,0,0,0,0,0],
    [0,0,7,0,5,0,0,0,6],
    [0,0,0,3,0,7,0,0,0],
    [5,0,0,0,1,0,7,0,0],
    [0,0,0,0,0,0,1,0,9],
    [0,2,0,6,0,0,0,5,0],
    [0,5,4,0,0,8,0,7,0]]

hard = [
    [0,0,3,0,0,0,4,0,0],
    [0,0,0,0,7,0,0,0,0],
    [5,0,0,4,0,6,0,0,2],
    [0,0,4,0,0,0,8,0,0],
    [0,9,0,0,3,0,0,2,0],
    [0,0,7,0,0,0,5,0,0],
    [6,0,0,5,0,2,0,0,1],
    [0,0,0,0,9,0,0,0,0],
    [0,0,9,0,0,0,3,0,0]]

very_hard = [
    [0,0,0,0,0,0,0,0,0],
    [0,0,9,0,6,0,3,0,0],
    [0,7,0,3,0,4,0,9,0],
    [0,0,7,2,0,8,6,0,0],
    [0,4,0,0,0,0,0,7,0],
    [0,0,2,1,0,6,5,0,0],
    [0,1,0,9,0,5,0,4,0],
    [0,0,8,0,2,0,7,0,0],
    [0,0,0,0,0,0,0,0,0]]

```

Local search for constraint problems

- Remember local search?
- There's a version of local search for CSP problems
- Basic idea:
 - generate a random “solution”
 - Use metric of “number of conflicts”
 - Modifying solution by reassigning one variable at a time to decrease metric until solution found or no modification improves it
- Has all features and problems of local search like....?

Min Conflict Example

- **States:** 4 Queens, 1 per column
- **Operators:** Move a queen in its column
- **Goal test:** No attacks
- **Evaluation metric:** Total number of attacks

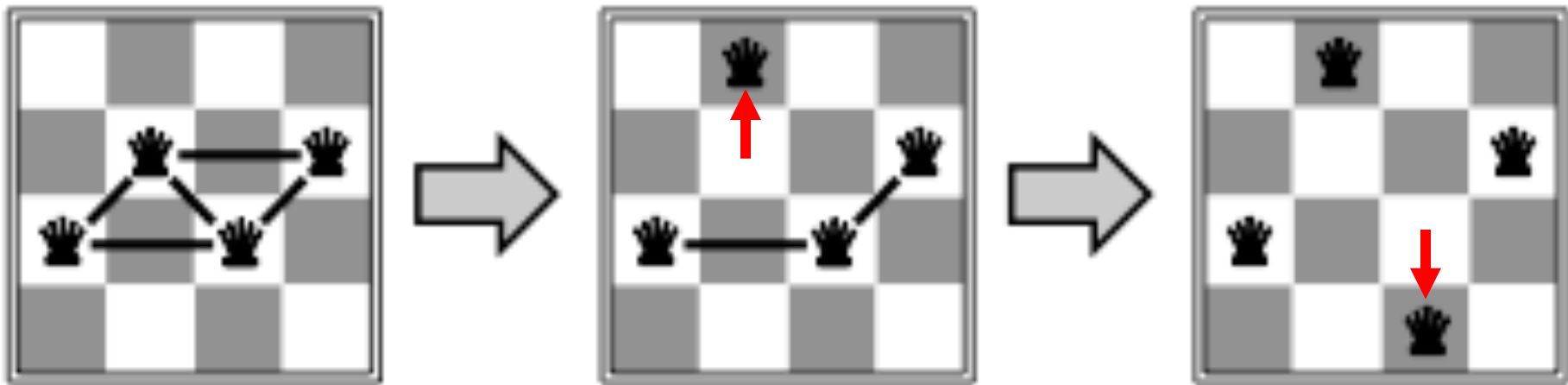

How many conflicts does each state have?

Basic Local Search Algorithm

Assign one domain value d_i to each variable v_i
while no solution & not stuck & not timed out:

bestCost $\leftarrow \infty$; bestList $\leftarrow []$;

for each variable $v_i \mid \text{Cost}(\text{Value}(v_i)) > 0$

for each domain value d_i of v_i

if $\text{Cost}(d_i) < \text{bestCost}$

bestCost $\leftarrow \text{Cost}(d_i)$; bestList $\leftarrow [d_i]$;

else if $\text{Cost}(d_i) = \text{bestCost}$

bestList $\leftarrow \text{bestList} \cup d_i$

Take a randomly selected move from bestList

Eight Queens using Backtracking

Undo move
for Queen 7
and so on...

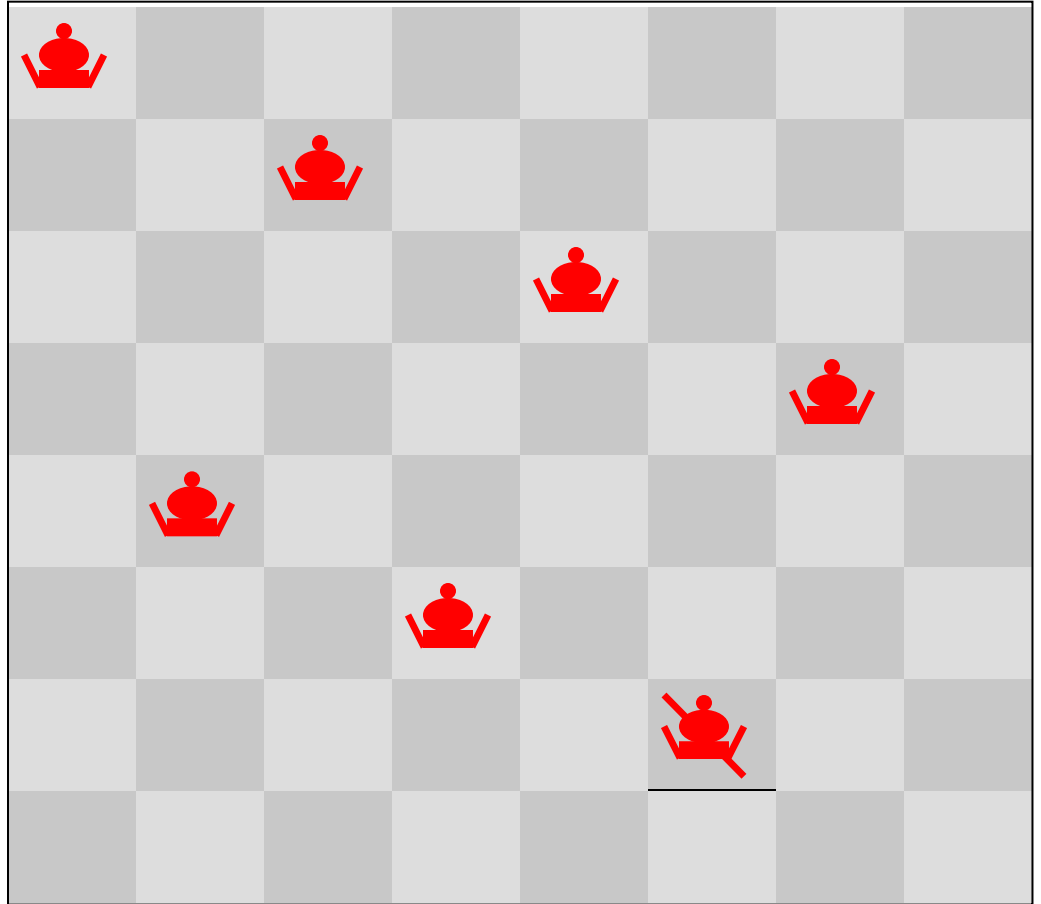

Eight Queens using Local Search

Answer Found

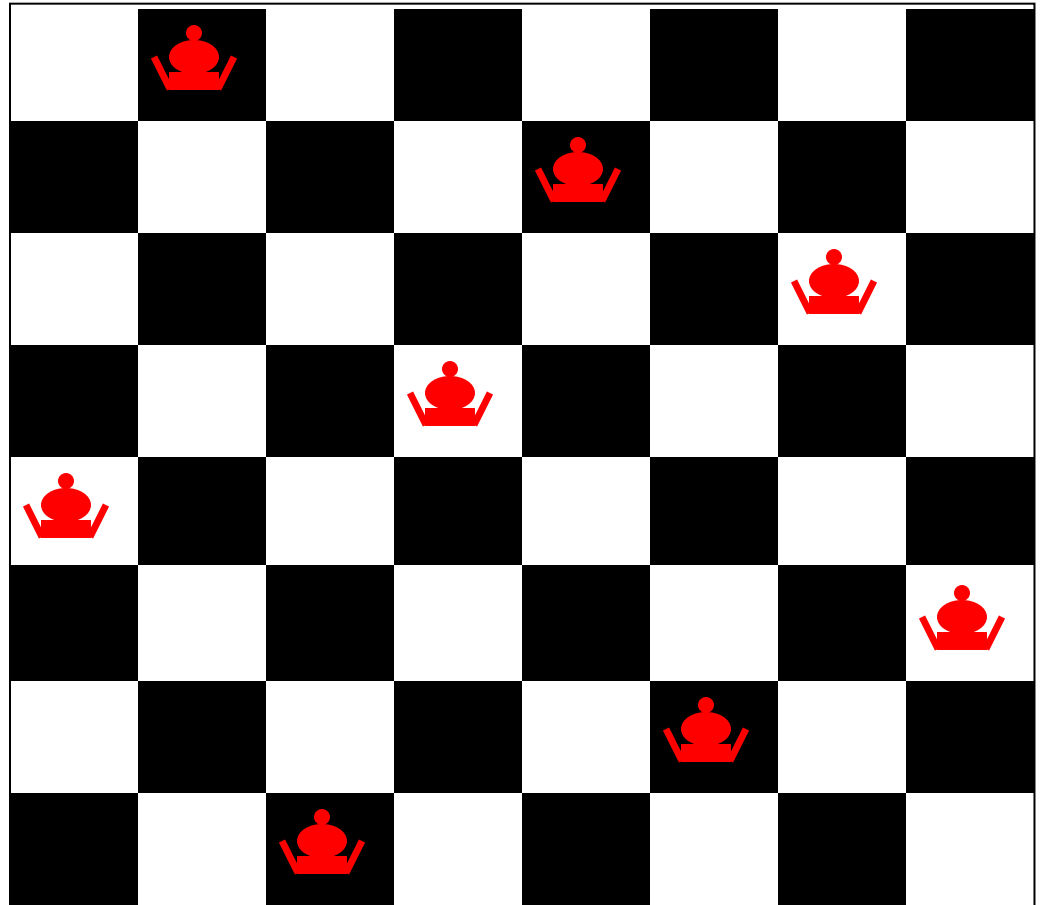

Backtracking Performance

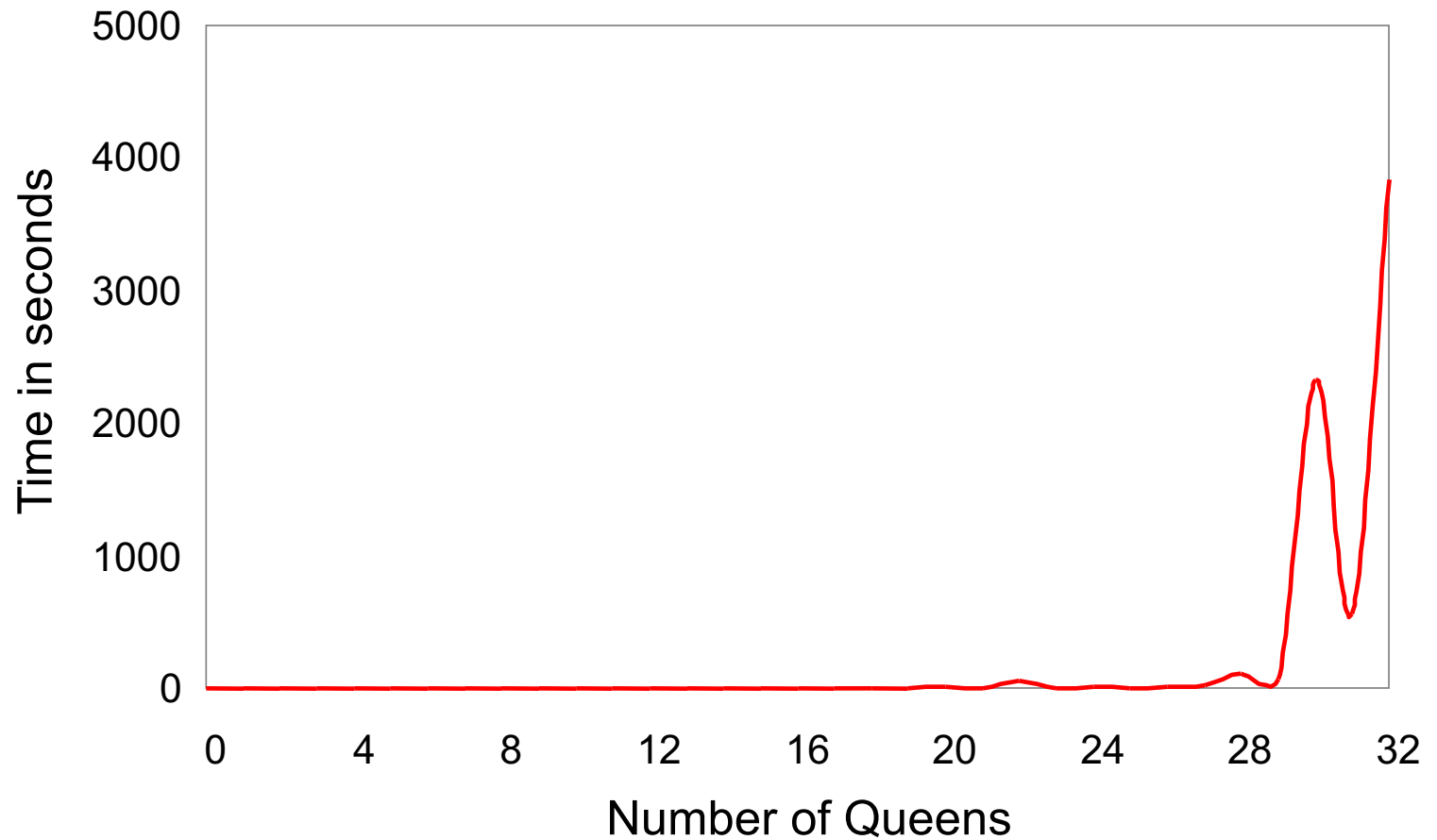

Local Search Performance

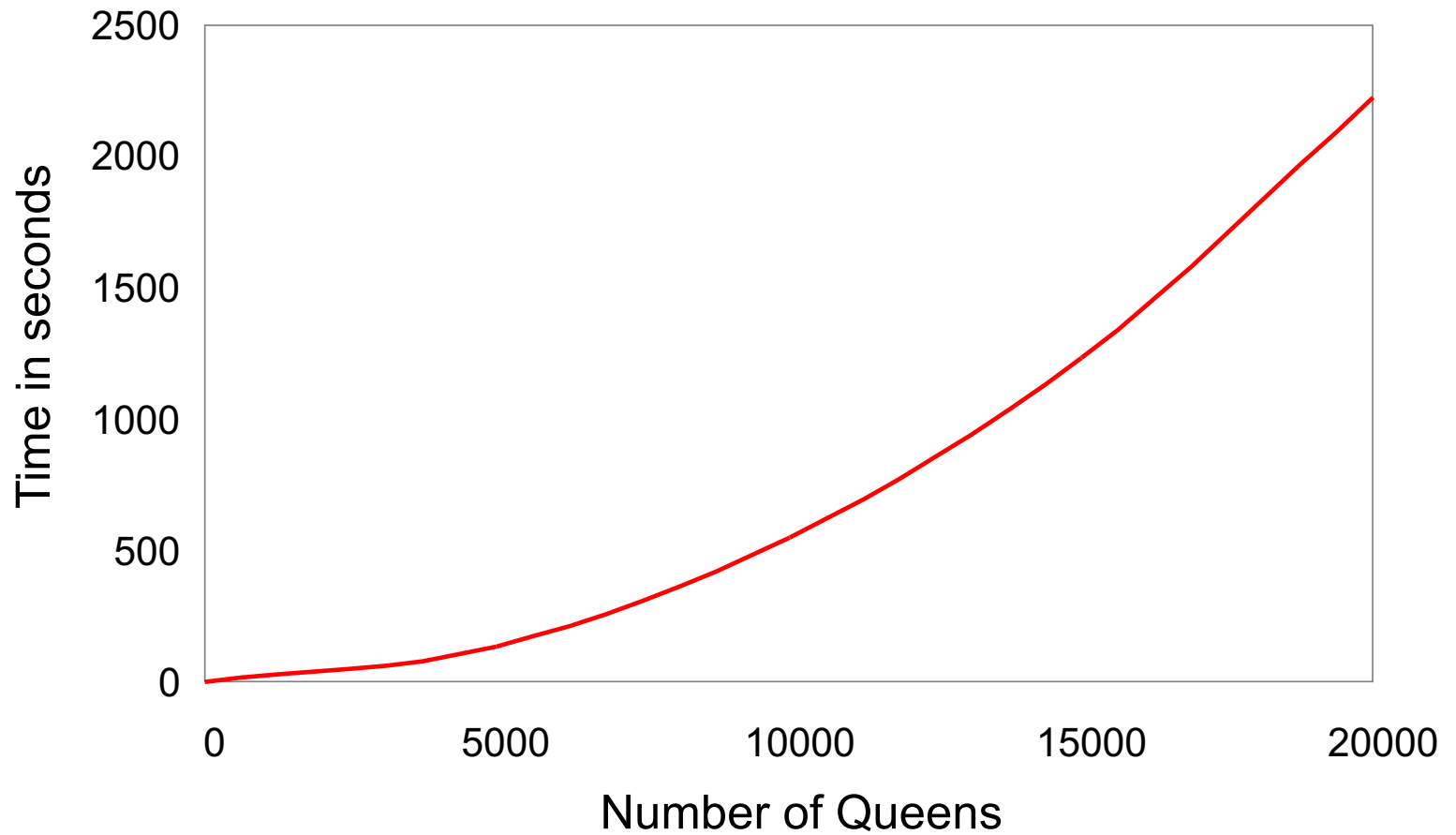

Min Conflict Performance

- Performance depends on quality and informativeness of initial assignment; inversely related to distance to solution
- Min Conflict often has astounding performance
- Can solve arbitrary size (i.e., millions) N-Queens problems in constant time
- Appears to hold for arbitrary CSPs with the caveat...

Min Conflict Performance

Except in a certain critical range of the ratio constraints to variables.

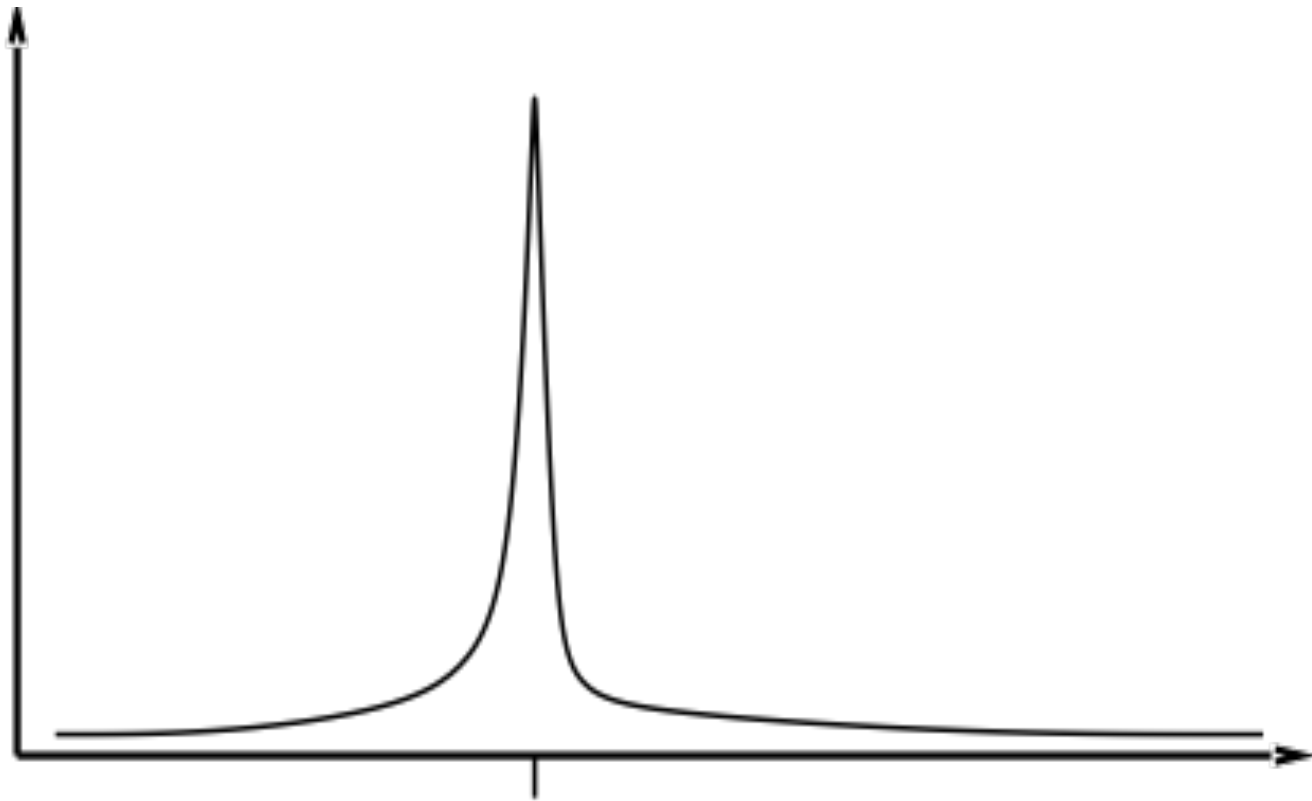

Famous example: labeling line drawings

- [Waltz](#) labeling algorithm, earliest AI CSP application (1972)
 - Convex interior lines labeled as +
 - Concave interior lines labeled as -
 - Boundary lines labeled as \pm with background to left
- 208 labeling possible labelings, but only 18 are legal

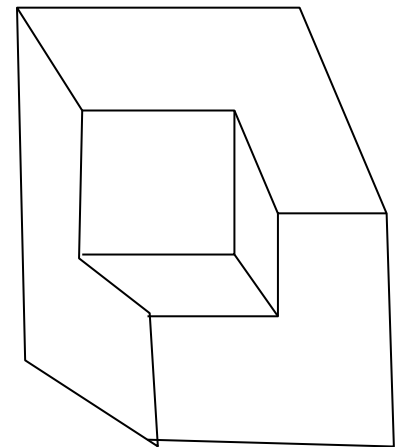
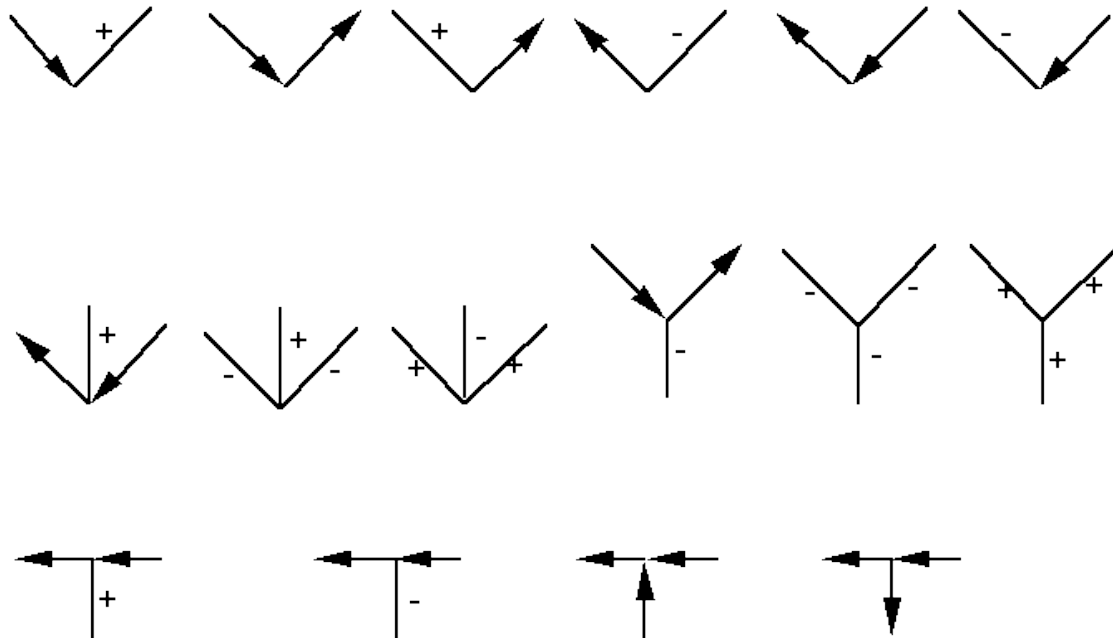

Labeling line drawings II

Here are some illegal labelings

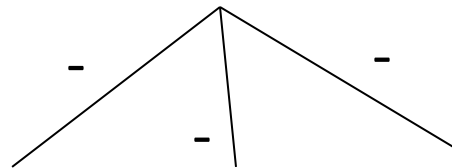
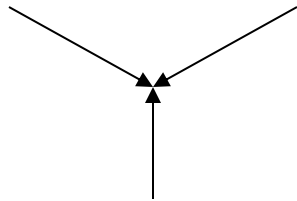
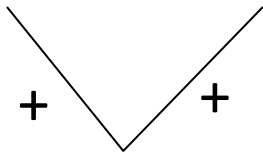

Labeling line drawings

Waltz labeling algorithm: propagate constraints repeatedly until a solution is found

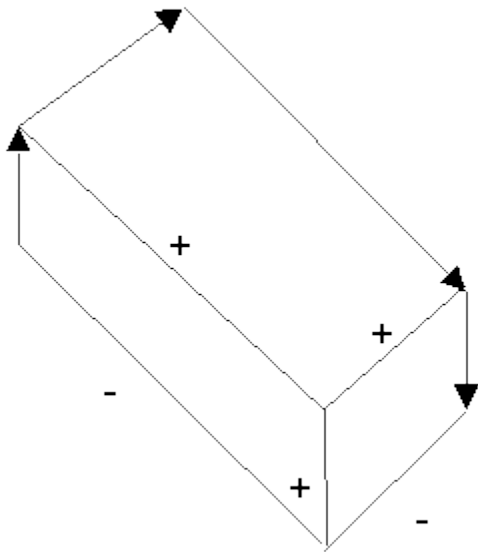

solution for one
labeling problem

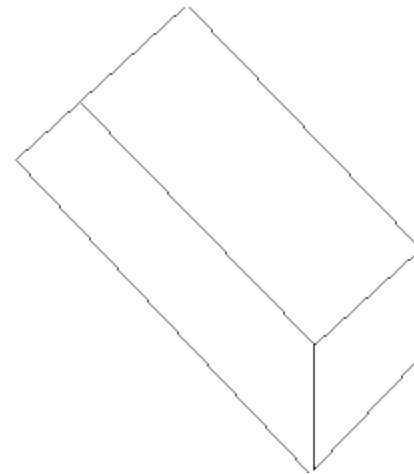

labeling problem
with no solution

Labeling line drawings

This line drawing is ambiguous, with two interpretations

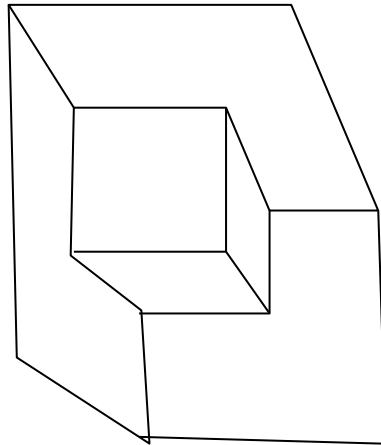

Shadows add complexity

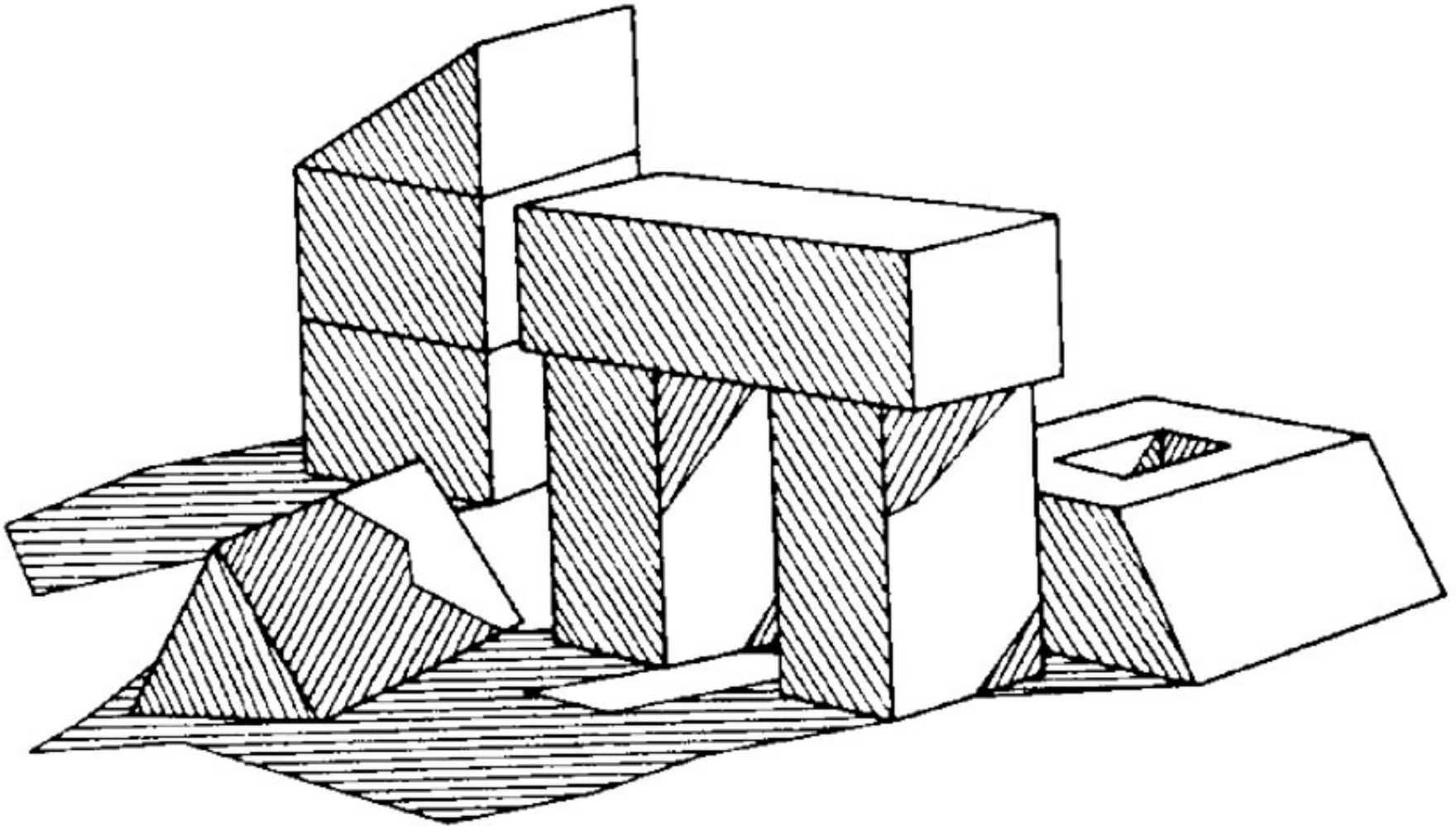

CSP was able to label scenes where some of the lines were caused by shadows

Challenges for constraint reasoning

- What if not all constraints can be satisfied?
 - Hard vs. soft constraints vs. preferences
 - Degree of constraint satisfaction
 - Cost of violating constraints
- What if constraints are of different forms?
 - Symbolic constraints
 - Logical constraints
 - Numerical constraints [constraint solving]
 - Temporal constraints
 - Mixed constraints

Summary

- Many problems can be effectively modeled as constraints solving problems
- The approach is very good at reducing the amount of search needed
- Arc consistency is simple yet powerful
- Constraints are also useful for local search
- There's a lot of complexity in many real-world problems that require additional ideas and tools

Challenges for constraint reasoning

- What if constraints are represented [intentionally](#)?
 - Cost of evaluating constraints (time, memory, resources)
- What if constraints, variables, and/or values change over time?
 - Dynamic constraint networks
 - Temporal constraint networks
 - Constraint repair
- What if multiple agents or systems are involved in constraint satisfaction?
 - Distributed CSPs
 - Localization techniques